



Xcelite®



Precision Screwdrivers, Nutdrivers, Pliers, Cutters and Tool Kits



Originating from a tiny metalworking company in 1921,
the Xcelite® brand of precision hand tools has been a

favorite of service technicians for over 75 years. It is now known throughout the electronics industry for its full line of high quality precision screwdrivers, nutdrivers, pliers, cutters, interchangeable-blade sets, specialized tools and kits.

Table of Contents

Contents	Page No.
Xcelite® tool selection guide	1 - 3
Screwdrivers, battery powered	4
Screwdrivers, for slotted screws, Phillips®, and Torx®	4 - 11
Screwdriver sets	11
Screwdrivers, Allen® hex socket type, and Ballpoint style	12 - 14
Combination reversible screwdrivers and kits	14 - 17
Nutdrivers-fixed handles—inch and Metric sizes	17 - 21
Compact convertible tool sets	21 - 24
Series 99® blades, shanks, handles and kits	25 - 33
Series 99® compact interchangeable-blade sets	34 - 38
Plier selection information	39
Cutting capability guide	40
Diagonal cutting pliers	41 - 47
Diagonal end cutting pliers	48
Diagonal chain nose pliers	49
Diagonal long needle nose pliers	49 - 53
Needle nose pliers	54 - 55
Electronics pliers handy pack assortment	56
Electronic shearcutters and pliers	57 - 59
Pliers and cutters	60 - 62
Utility Pliers	63
Special tools for special problems	63 - 66
Tweezers	67
Precision knives and blades	98 - 69
Multi-purpose tool kit	70
Xcelite® attaché tool cases	71 - 81
Tools for cable terminals and connectors	82 - 93
Xcelite® Numerical Index	94 - 96

Phillips® is a registered trademark of The Phillips Screw Co.
Torx® is the trademark of Camcar Division of Textron Inc.
Allen® is a registered trademark of Holo Krane, Technology Corp.
Pozidriv® is a registered trademark of Camcar Division of Textron, Inc.
Belden® is a registered trademark of Belden, Inc.

FEATURE CODES

E = (Prefix) "Accu-Lite" Grips
V = Blister carded
J = Flush cutting edges
K = Semi-flush cutting edges
S = Coil spring
G = Smooth jaws

Xcelite® Tool Selection Guide

Allen® Type Hex Socket Screws

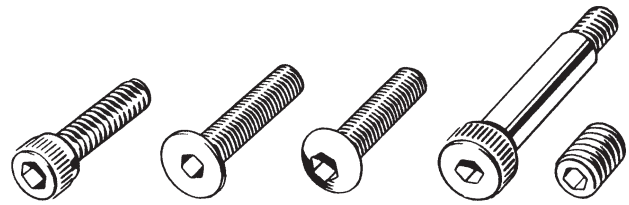

Xcelite driver or blade

Cap screws 1960 series Nominal screw sizes	1936 series	Flat head cap screws	Button head cap screws	Shoulder screws	Set screws	Catalog number	Hex size (inches)
-	-	-	-	-	0	P18	.028
-	-	0	0	-	1&2	P19	.035
0	0&1	1&2	1&2	-	3&4	LN20, P20, 9920	.050
1	2	3&4	3&4	-	5&6	LN21, P21, 9921	1/16
2&3	3&4	5&6	5&6	-	8	LN22, P22, 9922	5/64
4&5	5&6	8	8	-	10	LN23, P23, 9923	3/32
6	-	-	-	-	-	LN764, P764, 99764	7/64
-	8	10	10	1/4	1/4	LN24, P24, 9924	1/8
8	-	-	-	-	-	LN964, P964, 99964	9/64
10	10&12	1/4	1/4	5/16	5/16	LN25, 9925	5/32
1/4	1/4	5/16	5/16	3/8	3/8	LN26, 9926	3/16
-	5/16	3/8	3/8	-	7/16	LN27	7/32
5/16	-	7/16	-	1/2	1/2	LN28	1/4

Note:

P Series = midget drivers in PS89 sets.

LN Series = fixed handle drivers. Same size available also in LN20BP through LN28BP ballpoint fixed handle drivers.

Series 99® = interchangeable blades. Same sizes available also in 9920BP through 9926BP ballpoint blades.

See also offset ratchet screwdriver sets.

Phillips® Type Screws

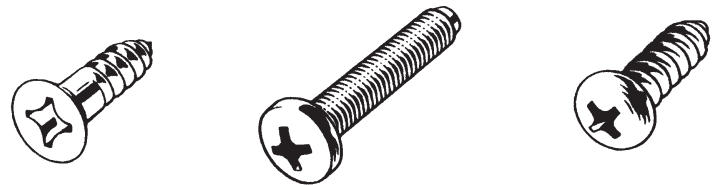

Xcelite driver or blade

Wood screw		Machine screw		Sheetmetal	Flat, round oval, stove binding	Point size	Blade diameter (inches)
Flat oval	Round	Flat oval binding	Round fillister	Truss brazier button			
0.1	0.1	0.1	0.1	-	-	0	1/8
2, 3, 4	2, 3, 4	2, 3, 4	2, 3, 4	2, 3, 4, 5	2, 3, 4	1	3/16
5, 6, 7	5, 6, 7	5, 6, 8	5, 6, 8	6, 8, 10	5, 6, 7		
8, 9	8, 9, 10	10	10		8, 10	2	1/4
10, 12	12, 14	12, 1/4"	12, 1/4"	12, 1/4"	12, 14		
14, 16	16		5/16"			3	5/16
18, 20	18, 20	5/16", 3/8"	3/8", 7/16"	5/16", 3/8"	-		
24	24	7/16", 1/2"	1/2"	7/16", 1/2"		4	3/8

Note: See fixed handle drivers; compact convertible sets; Series 99® sets and interchangeable blades; combination reversible drivers, kits, and blades, offset ratchet screwdriver sets.

Xcelite

Xcelite® Tool Selection Guide

Bristol Type Multiple-spline Socket Screws

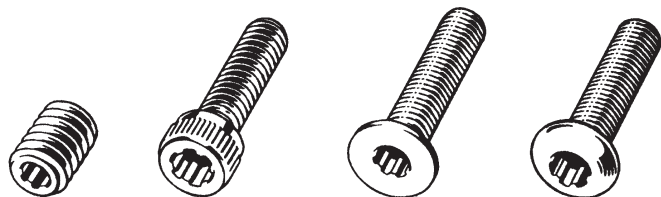

Xcelite blade

Set screws	Cap screws 1960 series	Flat head	Button head	Catalog number	Tip size (inches)	Number of flutes
No. 2-No. 3	-	No. 0	No. 0	9961	.048	6
No. 4	No. 0	No. 1-No. 2	No. 1-No. 2	9962	.060	6
No. 5	-	-	-	9963	.069	4
No. 5-No. 6	No. 1	No. 3-No. 4	99-64	9964	.072	6
No. 6	-	-	-	9965	.076	4
No. 8	No. 2-No. 3	No. 5-No. 6	No. 5-No. 6	9966	.096	6
No. 10	No. 4-No. 5	No. 8	No. 8	9967	.111	6
1/4"	-	No. 10	No. 10	-	.145	6
5/16"	No. 10	1/4"	1/4"	9969	.183	6

Note: See 99PS-60 compact interchangeable blade set and Series 99® blades.

Slotted Screws

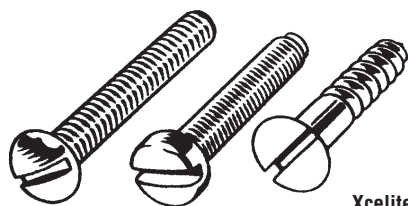
Xcelite driver
or blade

Screw size	Tip size (inches)
0	3/32
1	3/32
2	1/8
3	5/32
4	3/16
5	3/16
6	1/4
7	1/4
8	5/16
9	5/16
10	5/16
12	3/8
14	3/8
16	7/16
18	7/16

Hex Head Screws

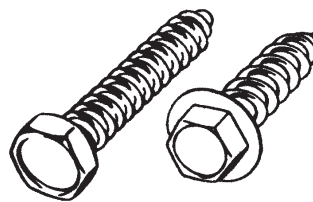
Xcelite driver
or blade

Screw size	Screw diameter (inches)	Number*	Hex opening (inches)
1	.073	4	1/8
2	.086	4	1/8
3	.099	6	3/16
4	.112	6	3/16
5	.125	6	3/16
6	.138	8	1/4
7	.151	8	1/4
8	.164	8	1/4
10	.190	10	5/16
12	.216	10	5/16
1/8	.250	12	3/8
1/8	.312	16	1/2
1/8	.375	18	9/16

*See fixed handle drivers catalog numbers with or without prefix P, HS, A or AA, magnetic nutdrivers with suffix M; and Series 99® blades with prefix 99.

Note: See round and square blade fixed handle drivers, compact convertible sets, Series 99® kits and interchangeable blades, combination reversible blade drivers and kits, offset ratchet screwdriver sets.

Xcelite® Tool Selection Guide

Hex Head Bolts and Hex Head Cap Screws

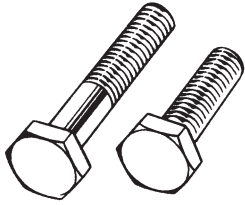

Xcelite
nutdriver or blade

Bolt or screw size	Number*	Hex opening (inches)
1/4	14	7/16
5/16	16	1/2
3/8	18	9/16
7/16	20	5/8
1/2	24	3/4

*See fixed handle drivers catalog numbers with or without prefix P, HS, A, or AA; Magnetic nutdrivers with suffix M; and Series 99® blades with prefix 99.

Torx® Screws

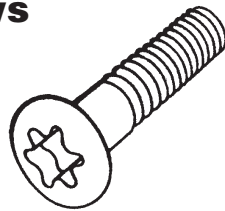

Xcelite
Driver

Torx size	Catalog Number
T8	XTD8
T10	XTD10
T15	XTD15
T20	XTD20
T25	XTD25
T27	XTD27
T30	XTD30

Hex Nuts

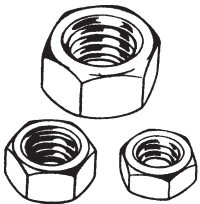

Xcelite
nutdriver or blade

Nut size	Number*	Hex opening (inches)
1/4	14	7/16
5/16	16	1/2
3/8	18	9/16
7/16	22	11/16
1/2	24	3/4

*See fixed handle drivers catalog numbers with or without prefix P, HS, A, or AA; Magnetic nutdrivers with suffix M; and Series 99® blades with prefix 99.

Hex Machine Screw Nuts

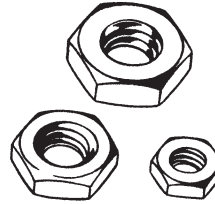

Xcelite
nutdriver or blade

Nut size	For screw diameter	Number*	Hex opening (inches)
0	.060	5	5/32
1	.073	5	5/32
2	.086	6	3/16
3	.099	6	3/16
4	.112	8	1/4
5	.125	10	5/16
6	.138	10	5/16
8	.164	11	11/32
10	.190	12	3/8
12	.216	14	7/16
1/4	.250	14	7/16
5/16	.312	18	9/16
3/8	.375	20	5/8

*See fixed handle drivers catalog numbers with or without prefix P, HS, A or AA, magnetic nutdrivers with suffix M; and Series 99® blades with prefix 99.

XP1 Cordless Driver



XP1 kit contains a driver, battery, battery charger, 3 bits, and 1 adapter for use with all Xcelite® Series 99® interchangeable bits

Features:

- Multi-stage clutch
- 2-speed control: Low speed of 180 RPMs; High speed of 360 RPMs
- 3.6v Nickel-Cadmium battery
- Battery charger for a quick 1 hour charge
- UL and cUL approved charger
- Motor: 3.6v DC
- Maximum clutch torque: Low 28.5 in. lbs.; High 14 in. lbs.
- Overall driver length is 10.8"

Cat No.	UPC No.	Packed	Description	Pack Wt.		Shelf Pack
				lb	kg	
XP1	037103142191	Boxed	Cordless driver kit with battery, charger, bits	2.6	1.16	1
XP1B	037103142177	Carded	Battery for cordless driver	0.4	0.18	1
XP1CHG	037103165329	Boxed	Battery charger for cordless driver	0.7	0.34	1

Precision Electronic Screwdriver Sets

Xcelite



- ESD safe to provide protection to ESD sensitive items
- Chrome-molybdenum vanadium steel blades provide superior strength
- Fast turning swivel caps w/cavity provides optimum control for precise centering
- Black oxide tips for longer wear life
- No-roll handle design keeps drivers from rolling off uneven surfaces
- Storage case provides a home and keeps drivers safe

Cat No.	UPC No.	Packed	Description	Shelf Pack
XP600	037103157513	Boxed	6 piece ESD safe slotted/Phillips® screwdriver set with storage case	1
XPTX600	037103157720	Boxed	6 piece ESD safe Torx® screwdriver set with storage case	1

XP600 contains 1 each of:

- 1.5mm x 60mm slotted tip screwdriver
- 2.0mm x 60mm slotted tip screwdriver
- 2.5mm x 60mm slotted tip screwdriver
- 3.0mm x 60mm slotted tip screwdriver
- #0 point Phillips® tip screwdriver
- #00 point Phillips® tip screwdriver

XPTX600 contains 1 each of:

- #5 point standard Torx® tip screwdriver
- #6 point standard Torx® tip screwdriver
- #7 point tamper-proof standard Torx® tip screwdriver
- #8 point tamper-proof standard Torx® tip screwdriver
- #10 point tamper-proof standard Torx® tip screwdriver
- #15 point tamper-proof standard Torx® tip screwdriver

Precision Electronic Screwdriver Sets

- Superior overall design for maximum control, accuracy and durability
- Chrome-molybdenum vanadium steel blades
- Fast-turning swivel caps with cavity for precise centering
- Precision tolerance black tips
- No-roll handle design



XP700 Kit Contents

1.5mm Slotted
2.0mm Slotted
2.5mm Slotted
3.0mm Slotted
#00 Phillips®
#0 Phillips®
#1 Phillips®

Cat No.	UPC No.	Packed	Description	Shelf Pack
XP700	037103126832	Clamshell	7 piece set	1

Pro Series Electronic Screwdrivers and Sets

- The handle core is made of hard shockproof plastic for durability, while the outer coating is soft rubber for comfort and slip resistance
- ESD safe hard plastic core to protect sensitive components
- The handles are ergonomically designed, allowing sustained high torque with minimal slippage and muscle fatigue
- Smooth shatterproof seamless handle cap for minimal friction between hand and handle when screwdriver is being turned
- Narrow pinch grip for comfort and control
- Thumb bolster allows added downward force
- Satin finish chrome molybdenum steel shafts provide durability
- Specially treated black oxide tips eliminate light reflection



XP700

Cat No.	UPC No.	Packed	Contents	Shelf Pack
XP500	037103183323	Hanging Display Box	XPE101, XPE102, XPE3166, XPE144, XPE184	1
XP700	037103153838	Hanging Display Box	XPE101, XPE102, XPE3166, XPE144, XPE184, XPE5324, XPE5166	1

Screwdrivers for Slotted Screws

Except where otherwise noted, all blades are AISI 6150 chrome vanadium steel, plated for protection.

Pocket Clip Style - Round Blade



- Blade made from AISI 6150 chrome vanadium steel

Cat No.	UPC No.	Packed	Blade Diameter		Length		Screwdriver Length		Shelf Pack
			Inch	mm	Inch	mm	Inch	mm	
R3322	037103485656	Boxed	3/32	2	51	4 1/4	108	12	
R3322V	037103485663	Carded	3/32	2	51	4 1/4	108	12	
R3323	037103485670	Boxed	3/32	3	76	5 1/4	133	12	
R3323V	037103488725	Carded	3/32	3	76	5 1/4	133	6	
R3324	037103485687	Boxed	3/32	4	102	6 1/4	159	12	
R3324V	037103488732	Carded	3/32	4	102	6 1/4	159	6	
R181	037103485458	Boxed	1/8	2	51	4 1/4	108	12	
R181V	037103485465	Carded	1/8	2	51	4 1/4	108	12	
R183	037103485489	Boxed	1/8	3	76	5 1/4	133	6	
R183V	037103488688	Carded	1/8	3	76	5 1/4	133	6	

Xcelite

Display Cards



- Xcelite® Catalog No. 18120 consists of 20 each R181 pocket clip screwdrivers on display card
- Xcelite® Catalog No. 33220 consists of 20 each R3322 pocket clip screwdrivers on display card
- Xcelite® Catalog No. P12S20 consists of 20 each P12S pocket clip screwdrivers on display card

Cat No.	UPC No.	Description	Shelf Pack
18120	037103483676	Card - 20 of R181	1
33220	037103483683	Card - 20 of R3322	1
P12S20	037103484864	Card - 20 of P12S	1

Regular - Round Blade



R184



R144



R3166



R148

Cat No.	UPC No.	Packed	Blade diameter		Blade length		Screwdriver length		Shelf Pack
			Inch	mm	Inch	mm	Inch	mm	
R182	037103485472	Boxed	1/8		2	51	4 5/8	117	6
R182V	037103488671	Carded	1/8		2	51	4 5/8	117	6
R183	037103485489	Boxed	1/8		3	76	5 1/4	133	6
R183V	037103488688	Carded	1/8		3	76	5 1/4	133	6
R184	037103485496	Boxed	1/8		4	102	6 5/8	168	6
R184V	037103485502	Carded	1/8		4	102	6 5/8	168	6
R186	037103485519	Boxed	1/8		6	152	8 5/8	219	6
R186V	037103485526	Carded	1/8		6	152	8 5/8	219	6
R188	037103485533	Boxed	1/8		8	203	10 5/8	270	6
R188V	037103485540	Carded	1/8		8	203	10 5/8	270	6
R1810	037103485571	Boxed	1/8		10	254	12 5/8	321	6
R5323	037103485731	Boxed	5/32		3	76	5 5/8	143	6
R5324	037103485748	Boxed	5/32		4	102	6 5/8	168	6
R5325	037103485755	Boxed	5/32		5	127	7 5/8	194	6
R3163	037103485588	Boxed	3/16		3	76	6 5/8	168	6
R3164	037103485601	Boxed	3/16		4	102	7 5/8	194	6
R3164V	037103485618	Carded	3/16		4	102	7 5/8	194	6
R3166	037103485625	Boxed	3/16		6	152	9 5/8	244	6
R3166V	037103485632	Carded	3/16		6	152	9 5/8	244	6
R3168	037103485649	Boxed	3/16		8	203	11 5/8	295	6
R31610	037103485786	Boxed	3/16		10	254	13 5/8	346	6
R144	037103485403	Boxed	1/4		4	102	8 1/8	206	6
R144V	037103485410	Carded	1/4		4	102	8 1/8	206	6
R146	037103485427	Boxed	1/4		6	152	10 1/8	257	6
R146V	037103485434	Carded	1/4		6	152	10 1/8	257	6
R148	037103485441	Boxed	1/4		8	203	12 1/8	308	6
R1410	037103485564	Boxed	1/4		10	254	14 1/8	359	6
R5164	037103485694	Boxed	5/16		4	102	8 1/2	216	6
R5166	037103485700	Boxed	5/16		6	152	10 1/2	267	6
R5168	037103485724	Boxed	5/16		8	203	12 1/2	317	6
R388	037103485557	Boxed	3/8		8	203	12 1/2	317	6

Round Blade Screwdriver Set



- Xcelite® Catalog No. SDR11 consists of 5 round blade screwdrivers for slotted screws (R182, R5324, R3166, R144 and R5166)

Cat No.	UPC No.	Packed	Description	Shelf Pack
SDR11	037103486103	Pouch	5 round blade screwdrivers for slotted screws	1

Stubby - Square Blade



- Stubby square blade screwdrivers
- Blades made of AISI 6150 chrome vanadium steel, plated for protection
- Handle color: Amber

Cat No.	UPC No.	Packed	Blade diameter		Blade length		Screwdriver length		Shelf Pack
			Inch	mm	Inch	mm	Inch	mm	
S3161	037103485922	Boxed	3/16		1 1/4	32	3 1/4	83	6
S141	037103485854	Boxed	1/4		1 1/4	32	3 1/4	83	6

Xcelite

Regular - Square Blade



- Regular square blade screwdrivers
- Blades made of AISI 6150 chrome vanadium steel, plated for protection
- Handle color: Amber

Cat No.	UPC No.	Packed	Blade diameter		Blade length		Screwdriver Length		Shelf Pack
			Inch	mm	Inch	mm	Inch	mm	
S3163	037103485939	Boxed	3/16		3	76	6 5/8	168	6
S3164	037103485953	Boxed	3/16		4	702	7 5/8	194	6
S3166	037103485977	Boxed	3/16		6	152	9 5/8	244	6
S144	037103485861	Boxed	1/4		4	102	8 1/8	206	6
S146	037103485885	Boxed	1/4		6	152	10 1/8	257	6
S5164	037103486028	Boxed	5/16		4	102	8 1/2	216	6
S5166	037103486035	Boxed	5/16		6	152	10 1/2	216	6
S5168	037103486059	Boxed	5/16		8	203	12 1/2	317	6
S388	037103485915	Boxed	3/8		8	203	12 1/2	317	6
S3812	037103486004	Boxed	3/8		12	305	18	457	6

Square Blade Screwdriver Set

- Xcelite® Catalog No. SDS44 consists of 5 square blade screwdrivers for slotted screws (S141, S3164, S144, S5166 and S388)



Cat No.	UPC No.	Packed	Description	Shelf Pack
SDS44	037103486110	Pouch	5 square blade screwdrivers for slotted screws	1

Screwdrivers for Recess Head Screws

- Screwdriver for recess head screws
- Pocket clip style - Phillips® type
- No. 0 x 2"



Cat No.	UPC No.	Packed	Point size	Blade diameter Inch	Blade length Inch	Blade length mm	Screwdriver length Inch	Screwdriver length mm	Shelf Pack
P12S	037103484857	Boxed	0	1/8	2	51	4 1/4	108	12
P12SV	037103486905	Carded	0	1/8	2	51	4 1/4	108	12

Stubby - Phillips® Type

- Stubby round blade screwdriver for Phillips® screws
- Blades made of AISI 6150 chrome vanadium steel, plated for protection
- Handle color: Amber



Cat No.	UPC No.	Packed	Point size	Blade diameter Inch	Blade length Inch	Blade length mm	Screwdriver length Inch	Screwdriver length mm	Shelf Pack
SX101	037103486226	Boxed	1	3/16	1 1/4	32	3 1/4	83	6
SX102	037103486233	Boxed	2	1/4	1 5/16	33	3 3/8	86	6

Regular – Phillips® Type



- Regular Phillips® type screwdrivers
- Blades made of AISI 6150 chrome vanadium steel, plated for protection
- Handle color: Amber

Cat No.	UPC No.	Packed	Point size	Blade diameter Inch	Blade length		Screwdriver length		Shelf Pack
					Inch	mm	Inch	mm	
X100	037103486370	Boxed	0	1/8	2	50	4 5/8	117	6
X101	037103486394	Boxed	1	3/16	3	76	6 5/8	168	6
X101V	037103486400	Carded	1	3/16	3	76	6 5/8	168	6
X108	037103486462	Boxed	1	3/16	6	152	9 5/8	244	6
X108V	037103486479	Carded	1	3/16	6	152	9 5/8	244	6
X102	037103486417	Boxed	2	1/4	4	102	8 1/8	206	6
X102V	037103486424	Carded	2	1/4	4	102	8 1/8	206	6
X103	037103486431	Boxed	3	5/16	6	152	10 1/2	267	6

Extra long – Phillips® Type



- Extra long Phillips® type screwdrivers
- Blades made of AISI 6150 chrome vanadium steel, plated for protection
- Handle color: Amber

Cat No.	UPC No.	Packed	Point size	Blade diameter Inch	Blade length		Screwdriver length		Shelf Pack
					Inch	mm	Inch	mm	
X1010	037103486486	Boxed	1	3/16	10	254	13 5/8	346	6
X1020	037103486493	Boxed	2	1/4	10	254	14 1/8	359	6

Super-tru Tip – Phillips® Type



- Super-tru tip for longer wear life and reduction of damage to screw head recesses, especially in smaller size fasteners
- Specially treated and finished tips with black oxide for ultimate control
- Bright, nickel chrome-plated blades

Cat No.	UPC No.	Packed	Point size	Blade diameter Inch	Blade length		Screwdriver length		Shelf Pack
					Inch	mm	Inch	mm	
XST100	037103486738	Boxed	0	1/8	2	50	4 5/8	117	6
XST100V	037103486745	Carded	0	1/8	2	50	4 5/8	117	6
XST101	037103486752	Boxed	1	3/16	3	76	6 5/8	168	6
XST101V	037103486769	Carded	1	3/16	3	76	6 5/8	168	6
XST102	037103486776	Boxed	2	1/4	4	102	8 1/8	206	6
XST102V	037103486783	Carded	2	1/4	4	102	8 1/8	206	6
XST1010	037103486790	Boxed	1	3/16	10	254	13 5/8	371	6
XST1020	037103486806	Boxed	2	1/4	10	254	14 1/8	371	6

Screwdrivers for Torx® Head Screws

- Screwdriver for Torx® head screws
- Blades made of AISI 6150 chrome vanadium steel, plated for protection



Cat No.	UPC No.	Packed	Tip size	Blade length		Screwdriver length		Shelf Pack
				Inch	mm	Inch	mm	
XTD6	037103490551	Boxed	T-6	3	76	6 5/8	168	6
XTD6V	037103490568	Carded	T-6	3	76	6 5/8	168	6
XTD8	037103490407	Boxed	T-8	3	76	6 5/8	168	6
XTD8V	037103490414	Carded	T-8	3	76	6 5/8	168	6
XTD10	037103488039	Boxed	T-10	3	76	6 5/8	168	6
XTD10XL	037103491312	Boxed	T-10	11	279	15 1/4	387	6
XTD15	037103488053	Boxed	T-15	3	76	6 5/8	168	6
XTD15XL	037103491329	Boxed	T-15	11	279	15 1/4	387	6
XTD20	037103488077	Boxed	T-20	3	76	6 5/8	168	6
XTD25	037103488091	Boxed	T-25	3	76	6 5/8	168	6
XTD27	037103488114	Boxed	T-27	4 1/2	105	8 5/8	220	6
XTD30	037103488138	Boxed	T-30	4 1/2	105	8 5/8	220	6

Driver sets



SDX22



XST3



XST5



SD3V



SRX33

- **SDX22** contains Phillips Xcelite® Catalog No. X100, X101, X102, X103, SX102
- **191** contains Xcelite® Catalog No. 5MM, 55MM, 6MM, 7MM, 8MM, 9MM and 10MM
- **XST3** contains Super-tru tip Phillips Xcelite® Catalog No. XST100, XST101, XST102

- **XST5** contains Super-tru Phillips Xcelite® Catalog No. XST100, XST101, XST102, XST1010 and XST1020
- **SD3V** contains pocket clip screwdrivers R181 and R3322 for slotted screws and P12S for Phillips head screws
- **SRX33** contains blades for slotted screws Xcelite® Catalog No. R184, R3166, R144, R5166 and Phillips Xcelite® Catalog No. X101 and X102

Cat No.	UPC No.	Packed	Shelf Description	Pack
SDX22	037103486127	Pouch	5 pieces – all Phillips	1
XST3	037103487353	Pouch	3 pieces – all Super-tru tip Phillips type	1
XST5	037103487360	Pouch	5 pieces – all Super-tru tip Phillips type	1
SD3V	037103486097	Carded	3 pocket clip screwdrivers for Phillips head screws	1
SRX33	037103486219	Pouch	6 pieces – 4 round blade for slotted screws and 2 Phillips types	1

Allen® Hex Socket Type Screwdrivers - Inch Sizes



LN25

- Allen® hex socket type screwdrivers
- Screwdriver for recessed socket head screws
- Inch sizes
- Color of handle: Amber

Cat No.	UPC No.	Packed	Blade diameter		Blade length		Screwdriver length		Shelf Pack
			Inch	mm	Inch	mm	Inch	mm	
LN20	037103484468	Boxed	.050		4	102	6 5/8	168	6
LN21	037103484475	Boxed	1/16		4	102	6 5/8	168	6
LN21V	037103488275	Carded	1/16		4	102	6 5/8	168	6
LN22	037103484482	Boxed	5/64		4	102	6 5/8	168	6
LN22V	037103488282	Carded	5/64		4	102	6 5/8	168	6
LN23	037103484499	Boxed	3/32		4	102	7 1/8	190	6
LN23V	037103488299	Carded	3/32		4	102	7 1/8	190	6
LN764	037103484550	Boxed	7/64		4	102	7 1/8	190	6
LN964	037103484567	Boxed	9/64		4	102	7 1/8	190	6
LN25	037103484512	Boxed	5/32		6	152	9 1/8	232	6

Allen® Hex Socket Type Screwdrivers - Metric Sizes



- Allen® hex socket type screwdrivers
- Screwdriver for recessed socket head screws
- Metric sizes
- Color of handle: Black

Cat No.	UPC No.	Packed	Blade diameter		Blade length		Screwdriver length		Shelf Pack
			Inch/ mm		Inch	mm	Inch	mm	
LN15MM	037103484277	Boxed	1.5		-	102	-	168	6
LN2MM	037103484284	Boxed	2		-	102	-	168	6
LN25MM	037103484291	Boxed	2.5		-	102	-	181	6
LN3MM	037103484307	Boxed	3		-	102	-	181	6
LN4MM	037103484314	Boxed	4		-	102	-	181	6

Roll-up Kits for Allen® Hex Socket Type

- Complete set of LN series Allen hex socket type and metric size screwdrivers
- Roll-up canvas case, plastic-coated for wear and protection



Cat No.	UPC No.	Packed	Description	Shelf Pack
LN11	037103484451	Canvas case	Complete set of LN series Allen hex type screwdrivers, 0.050" - 1/4"	1
LN8MM	037103484345	Canvas case	Complete set of 8 drivers w/black handles in metric sizes, 1.27mm thru 6mm	1

Ballpoint Style, Allen® Hex Socket Type

- Unique “ballpoint” tip makes Xcelite® drivers ideal for tightening and removing Allen type socket head screws in out-of-reach places or merely when wanting an easier, quicker way to drive them home
- Will engage screw head from any angle
- Slips easily into sockets and holds securely without reaming, because ends are precision-machined to close tolerance

Ballpoint Style, Allen® Hex Socket Type - Inch Sizes

- For easier tightening and removing of Allen type socket head screws
- Ballpoint tip
- Color of handle: Amber



Cat No.	UPC No.	Packed	Blade diameter		Blade length		Screwdriver length		Shelf Pack
			Inch	mm	Inch	mm	Inch	mm	
LN20BP	037103484574	Boxed	.050		4	102	6 5/8	168	6
LN21BP	037103484581	Boxed	1/16		4	102	6 5/8	168	6
LN22BP	037103484598	Boxed	5/64		4	102	6 5/8	168	6
LN23BP	037103484604	Boxed	3/32		4	102	7 1/8	181	6
LN764BP	037103484666	Boxed	7/64		4	102	7 1/8	181	6
LN964BP	037103484673	Boxed	9/64		4	102	7 1/8	181	6
LN25BP	037103484628	Boxed	5/32		4	102	7 1/8	181	6
LN28BP	037103484659	Boxed	1/4		4	102	8 1/8	206	6

Roll-up Kits for Ballpoint Style Allen® Hex Socket Type



- Ballpoint, Allen hex socket type screwdrivers
- Roll-up canvas case
- Inch sizes
- Color of handle: Amber

Cat No.	UPC No.	Packed	Description	Shelf Pack
LN9BP	037103484444	Canvas case	Inch sizes – 9 ballpoint, Allen hex socket type screwdrivers, 0.050" - 3/16"	1

Combination Reversible Screwdrivers and Kits

- Economical multi-purpose tool sets and kits consisting of either a regular or stubby handle combined with one or more of reversible, interchangeable combination blades
- Blades and handle may be purchased separately
- Blades snap in and out easily and are held firmly in perfect alignment by patented spring lock

Xcelite

No. 25 Handle



- Color of handle: Amber
- Use with reversible blades

Cat No.	UPC No.	Packed	Description	Handle dimensions		Shelf Pack
				Inch x Inch	mm x mm	
25	037103481337	Boxed	Screwdriver handle	1 1/8 x 4 1/8	29 x 105	6

Reversible Blades (Use with Number 25 Handle)

- Snaps in and out easily and held firmly in perfect alignment by patented spring lock

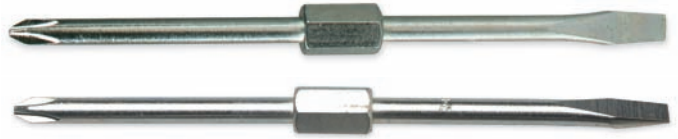

Cat No.	UPC No.	Packed	Blade diameter		Description	Blade length		Shelf Pack
			Inch	mm		Inch	mm	
RB1	037103485793	Boxed	3/16	5	No. 1 Phillips – 3/16" slotted	6 1/4	159	6
RB2	037103485809	Boxed	1/4	6	No. 2 Phillips – 1/4" slotted	6 1/4	159	6

Combination Reversible Blades and Handles

- Contains 1 reversible, interchangeable, combination blade
- Regular handle



Cat No.	UPC No.	Packed	Description	Screwdriver length		Shelf Pack
				Inch	mm	
CR1	037103483904	Boxed	No. 25 handle & RB1 blade	7 1/4	184.15	6
CR1V	037103483911	Carded	No. 25 handle & RB1 blade	7 1/4	184.15	6
CR2	037103483928	Boxed	No. 25 handle & RB2 blade	7 1/4	184.15	6
CR2V	037103483935	Carded	No. 25 handle & RB2 blade	7 1/4	184.15	6

Plastic View Kit

CK20

- Zipper case with RB1 and RB2 blades and No. 25 handle

CK23

- Zipper case with RB1, RB2 and RB3 blades and No. 25 handle



CK23

Cat No.	UPC No.	Description	Shelf Pack
CK20	037103483881	Zipper case with RB1, RB2 blades and No. 25 handle	6
CK23	037103483898	Zipper case with RB1, RB2 and RB3 blades and No. 25 handle	6

Pocket Roll Kit



- Contains RB1, RB2 and RB3 blades and Xcelite® Catalog No. 25 handle

Cat No.	UPC No.	Description	Shelf Pack
CK3	037103483874	Contains RB1, RB2 and RB3 blades with No. 25 handle	6

4-way Pocket Tool



- Extremely versatile time-saver
- Handy for removing backs of TV sets and installing antennas
- Special reversible SB1 blade fits slotted or Phillips head screws
- Double-ended handle serves as 2 sizes of nutdrivers (7/16" and 1/4")

Cat No.	UPC No.	Packed	Description	Shelf Pack
600	037103483690	Boxed	4-way pocket tool	6
600V	037103483706	Carded	4-way pocket tool	6

Four-in-One Screwdriver



- Extra handy
- 2 blades also interchangeable with Two-In-One
- Self-storing standard shaft
- Converts in seconds to 4 most often needed tips (3/16" and 1/4" slotted tips and Xcelite® Catalog No. 1 and 2 Phillips®)

Cat No.	UPC No.	Packed	Description	Shelf Pack
FSD1	037103487537	Boxed	Four-in-One screwdriver complete	6
FSD1V	037103487605	Carded	Four-in-One screwdriver complete	6

Two-in-One Screwdriver

- 3/16" slotted tip end and Xcelite® Catalog No. 1 Phillips®
- Stubby handle



Cat No.	UPC No.	Packed	Description	Shelf Pack
TSD1V	037103487612	Carded	Two-in-one screwdriver complete	6

Nutdrivers - Fixed Handle

- Features steel shafts
 - Precision-machined, cold-drawn, case-hardened sockets with bright finish
 - Molded firm grip
 - Plastic handles are color-coded for easy size identification
 - Xcelite® offers a variety of nutdriver blades that fit interchangeably in special handles
- See pages 305 and 306**

Regular Nutdrivers - Fixed Handle - Drilled Shaft

- Precision-machined, cold-drawn, case-hardened socket with bright finish
- Regular, plastic color-coded handles for ease in size identification
- Molded firm grip



Cat No.	UPC No.	Packed	Color code	Diameter Inch	Depth of hole	Blade length Inch	Blade length mm	Nutdriver length Inch	Nutdriver length mm	Shelf Pack
6	037103481054	Boxed	Black	3/16	1 1/8"	3	76	6 1/8	156	6
8	037103481108	Boxed	Red	1/4	1 1/8"	3	76	6 1/8	156	6
10	037103481177	Boxed	Amber	5/16	1 1/8"	3	76	6 1/8	156	6
10V	037103481214	Carded	Amber	5/16	1 1/8"	3	76	6 1/8	156	6
11	037103481221	Boxed	Green	11/32	1 1/8"	3	76	6 1/8	156	6
12	037103481252	Boxed	Blue	3/8	1 1/8"	3	76	6 1/8	156	6
14	037103481290	Boxed	Brown	7/16	1 7/8"	2 7/8	73	7	178	6

Regular Nutdrivers - Full Hollow Shaft - Inch Sizes

Color Coded Handles



- Precision-machined, cold-drawn, case-hardened socket with bright finish
- Molded firm grip

Cat No.	UPC No.	Packed	Color code	Blade diameter Inch	Depth of hole	Blade length Inch	Blade length mm	Screwdriver length Inch	Screwdriver length mm	Shelf Pack
HS6	037103484031	Boxed	Black	3/16	6"	3 1/8	79	6 1/4	159	6
HS7	037103484055	Boxed	Brown	7/32	6"	3 1/8	79	6 1/4	159	6
HS8	037103484062	Boxed	Red	1/4	7"	3 1/8	79	7 1/4	184	6
HS8V	037103484079	Carded	Red	1/4	7"	3 1/8	79	7 1/4	184	6
HS9	037103484086	Boxed	Orange	9/32	7"	3 1/8	79	7 1/4	184	6
HS9V	037103488657	Carded	Orange	9/32	7"	3 1/8	79	7 1/4	184	6
HS10	037103484093	Boxed	Amber	5/16	7"	3 1/8	79	7 1/4	184	6
HS10V	037103484109	Carded	Amber	5/16	7"	3 1/8	79	7 1/4	184	6
HS11	037103484116	Boxed	Green	11/32	7"	3 1/8	79	7 1/4	184	6
HS11V	037103484123	Carded	Green	11/32	7"	3 1/8	79	7 1/4	184	6
HS12	037103484130	Boxed	Blue	3/8	7"	3 1/8	79	7 1/4	184	6
HS12V	037103484147	Carded	Blue	3/8	7"	3 1/8	79	7 1/4	184	6
HS14	037103484154	Boxed	Brown	7/16	7"	3 1/8	79	7 1/4	184	6
HS14V	037103484161	Carded	Brown	7/16	7"	3 1/8	79	7 1/4	184	6
HS16	037103484178	Boxed	Red	1/2	7"	3 1/8	79	7 1/4	184	6
HS16V	037103484185	Carded	Red	1/2	7"	3 1/8	79	7 1/4	184	6
HS18	037103484192	Boxed	Orange	9/16	7"	3 1/8	79	7 1/4	184	6
HS18V	037103484208	Carded	Orange	9/16	7"	3 1/8	79	7 1/4	184	6

Xcelite

Extra Long Nutdrivers - Full Hollow Shaft - Inch Sizes

Color Coded Handles



- Precision-machined, cold-drawn, case-hardened socket with bright finish
- Molded firm grip

Cat No.	UPC No.	Packed	Color code	Blade diameter Inch	Depth of hole	Blade length Inch	Blade length mm	Screwdriver length Inch	Screwdriver length mm	Shelf Pack
L8	037103483720	Boxed	Red	1/4	9 3/4"	6	152	10 1/8	257	6
L10	037103483768	Boxed	Amber	5/16	9 3/4"	6	152	10 1/8	257	6
L11	037103483805	Boxed	Green	11/32	9 3/4"	6	152	10 1/8	257	6
L12	037103483829	Boxed	Blue	3/8	9 3/4"	6	152	10 1/8	257	6

Magnetic Nutdrivers

- Ultimate in convenience for assembly and service operations involving hex fasteners
- Alnico permanent magnet inserted in socket holds fasteners firmly for easy, one-hand driving or for retrieving or removal
- Socket specially treated and hardened for use with self-tapping screws
- Unique Xcelite® development effectively insulates magnet
- Exclusive with Xcelite® 1/4" and 5/16" magnetic fixed handle
- Comfortable contoured handle provides adequate torque for 1-hand driving



Cat No.	UPC No.	Packed	Handle color	Diameter Inch	Depth of hole	Blade length		Tool length		Shelf Pack
						Inch	mm	Inch	mm	
8M	037103481115	Boxed	Red	1/4	-	3	76	6 1/8	156	6
10M	037103481184	Boxed	Amber	5/16	-	3	76	6 1/8	156	6
L8M	037103483737	Boxed	Red	1/4	-	6	152	10 1/8	257	6
L8MV	037103483744	Carded	Red	1/4	-	6	152	10 1/8	257	6
L10M	037103483775	Boxed	Amber	5/16	-	6	152	10 1/8	257	6
L10MV	037103483782	Carded	Amber	5/16	-	6	152	10 1/8	257	6

Metric Nutdrivers

- Manufactured precisely to metric dimension
- Particularly useful in the assembly and servicing of foreign equipment
- Bright finished blades, shafts and shanks (same as English version)

Regular Nutdrivers - Drilled Shaft - Metric Sizes

- Particularly useful in assembly and servicing of foreign equipment
- Bright finished blades, shafts and shanks
- Manufactured precisely to metric dimension
- Handle color: Black



Cat No.	UPC No.	Packed	Blade Diameter mm	Depth of hole mm	Blade Length mm	Tool Length mm	Thread diameter		Hex nuts mm	Shelf Pack
							cap screws	Hex head mm		
4MM	037103481009	Boxed	4	29	76	156	-	-	2	6
5MM	037103481030	Boxed	5	29	76	156	2.6	2.6	2.6	6
55MM	037103481047	Boxed	5.5	29	76	156	3	3	3	6
7MM	037103481092	Boxed	7	29	76	156	4	4	4	6
8MM	037103481122	Boxed	8	29	76	156	5	5	5	6
10MM	037103481191	Boxed	10	48	73	178	6	6	6	6

Nutdrivers, Full - Hollow Shaft



- Particularly useful in assembly and servicing of foreign equipment
- Bright finished blades, shafts and shanks
- Manufactured precisely to metric dimension

Cat No.	UPC No.	Packed	Color code	Blade Diameter mm	Depth of hole mm	Blade length Inch	Blade length mm	Nutdriver length Inch	Nutdriver length mm	Shelf Pack
13MM	037103481283	Boxed	Black	13	178	-	79	-	184	6

Color Coded Nutdriver Sets - "Tray Bien"



- Contains assortment of nutdrivers listed in chart
- Convenient blow molded case

Cat No.	UPC No.	Description	Shelf Pack
127TB	037103483621	Contains solid shaft No's. 6, 7, 8, 9, 10, 11 and 12	1
147TB	037103483638	Contains hollow shaft No's. HS8, HS9, HS10, HS11, HS12, HS14, and HS166	1

Nutdriver Set



- Contains assortment of nutdrivers listed in chart
- Plastic pouch

Cat No.	UPC No.	Description	Shelf Pack
157	037103483652	Contains 7 pieces, all regular drilled shaft No's. 6, 8, 10, 11, 12, 14 and 16	1
177	037103483669	Contains 7 pieces, all hollow shaft No's. HS6, HS8, HS10, HS11, HS12, HS14 and HS16	1

Nutdriver Kit - "Keep and Carry" Case

- Contains assortment of nutdrivers listed in chart
- Sturdy yellow plastic case for inch sizes, and red case for metric sizes, keeps nutdrivers orderly on work bench and carries them on service calls



Cat No.	UPC No.	Description	Shelf Pack
HS618	037103484215	Inch sizes - Contains hollow shaft No's. HS6, HS7, HS8, HS9, HS10, HS11, HS12, HS14, HS16, and HS18	1
413MM	037103481023	Metric sizes - 10 piece set of nutdrivers: 4MM through 8MM, 10MM, 11MM, 13MM. All have 31.35mm depth shaft hole	1

Compact Convertible Tool Sets

- Compact convertible tool sets complete more jobs with fewer tools, save bench space and lighten service kits
- Each set is equipped with a remarkable black, "piggyback" torque amplifier handle (Xcelite® Catalog No. TA2) that slips over the top of color-coded midget drivers to provide larger gripping surface, extended reach and increased driving power
- Sets housed in attractive, easy to open, clear plastic cases
- All individual screwdrivers and nutdrivers are available separately

PS88 Screwdriver Set - Inch Sizes

- Handles more jobs with fewer tools, saves bench space and lightens service kit
- Equipped with remarkable black, "piggyback" torque amplifier handle
- Set housed in attractive, easy to open, clear plastic case
- Color-coded handles; 9 pieces



Cat No.	UPC No.	Packed	Handle color	Blade length		Screwdriver length		Shelf Pack
				Inch	mm	Inch	mm	
PS88	037103485236	Boxed	Complete set					3
PS88V	037103485243	Carded	Complete set carded					3
P3321	037103485052	-	Green	3/32	-	3 1/2	89	12
P1	037103484727	-	Brown	1 Phillips	-	3 1/2	89	12
TA2	037103486240	-	Black	Torque amplifier handle				6

PS120 Nutdriver Set - Inch Sizes



- Handles more jobs with fewer tools, saves bench space and lightens service kit
- Equipped with remarkable black, “piggyback” torque amplifier handle
- Set housed in attractive, easy to open, clear plastic case
- Color-coded handles

Cat No.	UPC No.	Packed	Handle color	Diameter Inch	Nutdriver length Inch	Nutdriver length mm	Shelf Pack
PS120	037103485281	Boxed	Complete set			3	
PS120V	037103485298	Carded	Complete set carded			3	
P4	037103484758	-	Red	1/8	3 1/2	89	12
P5	037103484765	-	Amber	5/32	3 1/2	89	12
P6	037103484772	-	Black	3/16	3 1/2	89	12
P8	037103484796	-	Red	1/4	3 1/2	89	12
P10	037103484826	-	Amber	5/16	3 1/2	89	12
TA2	037103486240	-	Black	Torque amplifier handle			3

PS121 MM Metric Compact Convertible Nutdriver Set

Xcelite



- Handles more jobs with fewer tools, saves bench space and lightens service kit
- Equipped with remarkable black, “piggyback” torque amplifier handle
- Set housed in attractive, easy to open, clear plastic case

Cat No.	UPC No.	Packed	Diameter mm	Nutdriver length mm	Shelf Pack
PS121MM	037103485304	Boxed	Complete set		3
△ P3MM	037103485076	-	3	89	12
△ P35MM	037103485083	-	3.5	89	12
TA2	037103486240	-	Torque amplifier handle		3

△ = Made to order, contact customer service for delivery.

PS130 Screwdriver and Nutdriver Set - Inch Sizes

- Handles more jobs with fewer tools, saves bench space and lightens service kit
- Equipped with remarkable black, “piggyback” torque amplifier handle
- Set housed in attractive, easy to open, clear plastic case
- Color-coded handles



Cat No.	UPC No.	Packed	Handle color	Blade Diameter Inch	Diameter Inch	Shelf Pack
PS130	037103485311	Boxed	Complete set			3
PS130V	037103485328	Carded	Complete set carded			3
Screwdrivers						
P1	037103484727	-	Brown	1 Phillips	-	12
Nutdrivers						
P6	037103484772	-	Black	-	3/16	12
P8	037103484796	-	Red	-	1/4	12
P10	037103484826	-	Amber	-	5/16	12
TA2	037103486240	-	Black	Torque amplifier handle		3

PS89 Screwdriver Set for Hex Socket Screws - Inch Sizes

- Handles more jobs with fewer tools, saves bench space and lightens service kit
- Equipped with remarkable black, “piggyback” torque amplifier handle
- Set housed in attractive, easy to open, clear plastic case
- Red handles



Cat No.	UPC No.	Packed	Diameter Inch	Tool length Inch	mm	Shelf Pack
PS89	037103485250	Boxed	Complete set			3
PS89V	037103485267	Carded	Complete set carded			3
P19	037103484888	-	.035	3 1/2	89	12
P20	037103484895	-	.050	3 1/2	89	12
P22	037103484918	-	5/64	3 1/2	89	12
P23	037103484925	-	3/32	3 1/2	89	12
TA2	037103486240	-	Torque amplifier handle			3

PS90MM Compact Convertible Hex Socket Screwdriver Set

Metric Sizes



- Handles more jobs with fewer tools, saves bench space and lightens service kit
- Equipped with remarkable black, “piggyback” torque amplifier handle
- Set housed in attractive, easy to open, clear plastic case
- Black handles

Cat No.	UPC No.	Packed	Diameter mm	Tool length mm	Shelf Pack
PS90MM	037103485274	Boxed	Complete set		3
TA2	037103486240	-	Torque amplifier handle		3

M60 Mini-driver Kit - Inch Sizes



- Miniature version of compact convertible set
- For precise detailed work
- Mini-drivers consist of jeweler’s type and Phillips® screwdriver blades molded in color-coded plastic handles
- Contains a black torque amplifier handle
- 7/8" X 3 1/16" / 22.22mm X 77.78mm
- Furnished in see-through plastic case
- Color-coded handles

Cat No.	UPC No.	Packed	Handle color	Blade Diameter Inch	Blade Diameter mm	Blade length Inch	Blade length mm	Tool length Inch	Tool length mm	Shelf Pack
M60	037103484680	Boxed	-	Complete set						6
M60V	037103484697	Carded	-	Complete set carded						6

Xcelite

Series 99® Blades, Shanks, and Handles

- Series 99® interchangeable blades, shanks and handles shown on these pages are all available separately, allowing gradual, economical accumulation of whatever items might be needed for individual requirements
- Also permits owners of Series 99® sets or kits to enlarge them or substitute tools, as necessary, at minimal cost

Handles

- Easy to operate
- Use with Series 99® blades



Cat No.	UPC No.	Packed	Description	Color	Handle dimensions		Shelf Pack
					Inch x Inch	mm x mm	
991	037103482532	Boxed	Regular	Amber	13/16 x 4	30 x 102	6
991V	037103482549	Carded	Regular	Amber	13/16 x 4	30 x 102	6
992	037103482570	Boxed	Junior	Amber	11/16 x 3 1/8	27 x 79	6
993	037103482594	Boxed	Stubby	Amber	13/16 x 2	30 x 51	6
994	037103482600	Boxed	Tee	Black	3 1/2 x 1 5/8	89 x 41	6
994V	037103482655	Carded	Tee	Black	3 1/2 x 1 5/8	89 x 41	6

Reversible Ratcheting Handles

- Easy to operate
- Permits extremely simple 1-hand operation, even in tight quarters
- Use with Series 99® blades
- Smooth precise action
- Left-right-neutral marking indicator
- Light ratcheting drag facilitates turning and prevents fasteners from reversing



Cat No.	UPC No.	Packed	Description	Color	Handle dimensions		Shelf Pack
					Inch x Inch	mm x mm	
991R	037103482556	Boxed	Regular	Black	1 x 7	25 x 178	6
994R	037103482631	Boxed	Tee	Black	3 1/2 x 2 1/2	89 x 64	6

Nutdrivers - Inch Sizes



996



9914



9912



9916

Cat No.	UPC No.	Packed	Diameter		Approximate working length		Shelf Pack
			Inch	mm	Inch	mm	
996	037103482693	Boxed	3/16		3 5/8	92	6
997	037103482716	Boxed	7/32		3 5/8	92	6
998	037103482747	Boxed	1/4		3 5/8	92	6
99S8	037103482396	Boxed	1/4		1 3/8	36	6
999	037103482792	Boxed	9/32		3 5/8	92	6
9910	037103482822	Boxed	5/16		3 5/8	92	6
99S10	037103482402	Boxed	5/16		1 3/8	36	6
9911	037103482853	Boxed	11/32		3 5/8	92	6
9912	037103482884	Boxed	3/8		3 5/8	92	6
99S12	037103482419	Boxed	3/8		1 3/8	36	6
9914	037103482907	Boxed	7/16		4	102	6
9916	037103482921	Boxed	1/2		4	102	6

Magnetic Nutdrivers - Inch Sizes



9910M

Cat No.	UPC No.	Packed	Diameter		Approximate working length		Shelf Pack
			Inch	mm	Inch	mm	
998M	037103482754	Boxed	1/4		3 5/8	92	6
9910M	037103482945	Boxed	5/16		3 5/8	92	6

Nutdrivers - Metric Sizes



998MM



9910MM

Cat No.	UPC No.	Packed	Diameter		Approximate working length		Shelf Pack
			mm	mm	Inch	mm	
994MM	037103482617	Boxed	4		-	92	6
995MM	037103482662	Boxed	5		-	92	6
9955MM	037103482679	Boxed	5.5		-	92	6
996MM	037103482686	Boxed	6		-	92	6
997MM	037103482723	Boxed	7		-	92	6
998MM	037103482761	Boxed	8		-	92	6
999MM	037103482808	Boxed	9		-	92	6
9910MM	037103482839	Boxed	10		-	102	6
9911MM	037103482860	Boxed	11		-	102	6



Slotted Screwdrivers



99312



99811

Cat No.	UPC No.	Packed	Diameter Inch	Approximate working length		Shelf Pack
				Inch	mm	
99125	037103483379	Boxed	1/8	4	102	6
99811	037103483447	Boxed	3/16	4	102	6
99811V	037103483454	Carded	3/16	4	102	6
99250	037103483393	Boxed	1/4	4	102	6
99250V	037103483409	Carded	1/4	4	102	6
99312	037103483416	Boxed	5/16	4	102	6



Phillips®



99822



99820

Cat No.	UPC No.	Packed	Description	Approximate working length		Shelf Pack
				Inch	mm	
99820	037103483461	Boxed	No. 0	4	102	6
99821	037103483485	Boxed	No. 1	4	102	6
99821V	037103483492	Carded	No. 1	4	102	6
99822	037103483508	Boxed	No. 2	4	102	6
99822V	037103483515	Boxed	No. 2	4	102	6



Pozidriv®



99831



99832

Cat No.	UPC No.	Packed	Description	Approximate working length		Shelf Pack
				Inch	mm	
99831	037103483522	Boxed	No. 1	4	102	6
99832	037103483539	Boxed	No. 2	4	102	6

Screwdrivers - Allen® Hex Socket Type

Inch Sizes



9923



9926

Cat No.	UPC No.	Packed	Diameter Inch	Approximate working length		Shelf Pack
				Inch	mm	
9920	037103482969	Boxed	.050	4	102	6
9921	037103482983	Boxed	1/16	4	102	6
9922	037103483003	Boxed	5/64	4	102	6
9923	037103483027	Boxed	3/32	4	102	6
99764	037103483102	Boxed	7/64	4	102	6
9924	037103483041	Boxed	1/8	4	102	6
99964	037103483119	Boxed	9/64	4	102	6
9925	037103483065	Boxed	5/32	4	102	6
9926	037103483089	Boxed	3/16	4	102	6

Screwdrivers - Allen® Hex Socket Type

Metric Sizes



9972MM



9976MM

Cat No.	UPC No.	Packed	Diameter mm	Approximate working length		Shelf Pack
				Inch	mm	
9971MM	037103483232	Boxed	1.27	-	102	6
9972MM	037103483249	Boxed	1.5	-	102	6
9973MM	037103483256	Boxed	2.0	-	102	6
9974MM	037103483263	Boxed	2.5	-	102	6
9975MM	037103483270	Boxed	3.0	-	102	6
9976MM	037103483287	Boxed	4.0	-	102	6
9977MM	037103483294	Boxed	5.0	-	102	6

Screwdrivers - Ballpoint Allen® Hex Socket Type

Inch Sizes



9924BP



9976MM

Cat No.	UPC No.	Packed	Diameter Inch	Approximate working length		Shelf Pack
				Inch	mm	
9920BP	037103482976	Boxed	.050	4	102	6
9921BP	037103482990	Boxed	1/16	4	102	6
9922BP	037103483010	Boxed	5/64	4	102	6
9923BP	037103483034	Boxed	3/32	4	102	6
99764BP	037103483430	Boxed	7/64	4	102	6
9924BP	037103483058	Boxed	1/8	4	102	6
99964BP	037103483553	Boxed	9/64	4	102	6
9925BP	037103483072	Boxed	5/32	4	102	6
9926BP	037103483096	Boxed	3/16	4	102	6

Screwdrivers - Bristol 6-flute Multiple Spline



9964



9969

Cat No.	UPC No.	Packed	Description	Diameter		Approximate working length		Shelf Pack
				Inch	mm	Inch	mm	
9961	037103483140	Boxed		0.048	1.22	4	102	6
9962	037103483157	Boxed		0.060	1.52	4	102	6
9963	037103483164	Boxed	4 flute	0.069	1.75	4	102	6
9964	037103483171	Boxed		0.072	1.82	4	102	6
9966	037103483195	Boxed		0.096	2.43	4	102	6
9967	037103483201	Boxed		0.111	2.82	4	102	6
9969	037103493224	Boxed		0.183	4.65	4	102	6



Screwdrivers - Torx®



998XTD



9927XTD

Cat No.	UPC No.	Packed	Tip Size	Approximate working length		Shelf Pack
				Inch	mm	
996XTD	037103490575	Boxed	T-6	4	102	6
998XTD	037103490582	Boxed	T-8	4	102	6
9910XTD	037103490025	Boxed	T-10	4	102	6
9915XTD	037103490032	Boxed	T-15	4	102	6
9920XTD	037103490049	Boxed	T-20	4	102	6
9925XTD	037103490056	Boxed	T-25	4	102	6
9927XTD	037103490063	Boxed	T-27	4	102	6
9930XTD	037103490070	Boxed	T-30	4	102	6

Reamer



Cat No.	UPC No.	Packed	Diameter		Approximate working length		Shelf Pack
			Inch x Inch	mm x mm	Inch	mm	
9938	037103483126	Boxed	1/8 x 3/8	3.17 x 9.52	4	102	6

Extensions



99X5

Cat No.	UPC No.	Packed	Description	Approximate working length		Tool Length		Shelf Pack
				Inch	mm	Inch	mm	
99X5	037103482501	Boxed	Extension	4	102	4	102	6
99X10	037103482525	Boxed	Extension	7	178	7	178	6
99X10V	037103487063	Carded	Extension	7	178	7	178	6

Power Bit Adapter



- For use with Xcelite® Series 99® blades
- Fits all power tools with 1/4" hex chuck

Cat No.	UPC No.	Packed	Description	Shelf Pack
99PA	037103490926	Boxed	Power bit adapter	6
99PAV	037103490933	Carded	Power bit adapter	6

Series 99® Service Kits

- Series 99® service kits and sets made primarily of various screwdrivers, nutdrivers and other blades that can be used interchangeably in Series 99® handles
- All blades are high quality steel, hardened and tempered for optimum performance
- Plastic handles have patented spring device that holds blades firmly, yet permits quick, easy insertion and removal
- Regular handles accommodate all blades, single and reversible
- Stubby, Tee and Ratchet handles used only with single-end blades

99SM & 99SMX Roll Kit & Case



99SM



99SMX

- Versatile 23-piece set of quality tools
- Provides a variety of quick change tools and tool combinations to speed up assembly and service work
- Available in a durable, roll-up plastic coated canvas case, or hard plastic case, for easy selection and storage

Cat No.	UPC No.	Packed	Inch	mm	Description	Shelf Pack
99SM	037103482471	Boxed	-	-	Complete roll kit	1
99SMK	037103482488	Boxed	-	-	Canvas case	1
99SMX	037103490254	Boxed	-	-	Complete tool kit w/carrying case	1
52NCGV	037103212931	-	6	152	Long nose cushion grip plier	6
55NCG	037103213297	-	5	127	Diagonal cushion grip plier	6
46CG	037103481467	-	6	152	Thin-pattern cushion grip adjustable wrench	6
991	037103482532	-	-	-	Regular handle	6
993	037103482594	-	-	-	Stubby handle	6
996 to 9916	-	-	-	-	Regular nutdrivers (9)	-
99S8, 99S10, 99S12	-	-	-	-	Stubby nutdrivers	-
99821, 99822	-	-	-	-	Phillips screwdrivers	-
99811, 99250	-	-	-	-	Slotted screwdrivers	-
9938	037103483126	-	-	-	Reamer	6
99X10	037103482525	-	-	-	Extension	6

99PR Roll Kit



- Multi-purpose, 14-piece nutdriver and screwdriver set

Cat No.	UPC No.	Packed	Inch	mm	Description	Shelf Pack
99PR	037103482266	Boxed	-	-	Complete roll kit	1
99K	037103482228	Boxed	-	-	Canvas case	1
991	037103482532	-	-	-	Regular handle	6
996 to 9916	-	-	-	-	Nutdrivers (9)	-
99811, 99250	-	-	-	-	Slotted screwdrivers	-
99821, 99822	-	-	-	-	Phillips screwdrivers	-

99SPC Personal Computer Repair Kit



- Ideal for repairs on PC's
- Contains 12 anti-static chip tools, protects chips from ESD damage
- Tools fit securely in a convenient roll-up pouch

Cat No.	UPC No.	Packed	Inch	mm	Description	Shelf Pack
99SPC	037103490940	Boxed	-	-	Complete kit	1
99820	037103483461	-	-	-	#0 Phillips screwdriver blade	6
99821	037103483485	-	-	-	#1 Phillips screwdriver blade	6
99811	037103483447	-	3/16	5	Slotted screwdriver blade	6
9910XTD	037103490025	-	-	-	Torx® screwdriver blade	6
9915XTD	037103490032	-	-	-	Torx® screwdriver blade	6
996	037103482693	-	3/16	5	Hex nutdriver shank	6
998	037103482747	-	1/4	6	Hex nutdriver shank	6
991	037103482532	-	-	-	Regular handle	6
Three-prong chip retriever/ extractor – antistatic						-
Chip tweezer, Chip inserter, Chip extractor – antistatic						-

99MP & 99MPX Multi-purpose Tool Kit

- 39-piece kit contains most popular Series 99® tools
- 2 extra pockets permit addition of pliers, snips or other tools
- Available in a durable, roll-up plastic coated canvas case for easy selection and storage



Cat No.	UPC No.	Packed	Inch	mm	Description	Shelf Pack
99MP	037103482235	Boxed	-	-	Complete kit	1
99MPK	037103482242	Boxed	-	-	Canvas case	1
991	037103482532	-	-	-	Regular handle	6
994	037103482600	-	-	-	Tee handle	6
998M	037103482754	-	-	-	Magnetic nutdriver	6
996, to 9916	-	-	-	-	Regular nutdrivers (9)	-
9920, to 9926	-	-	-	-	Allen hex screwdrivers (9)	-
99764, 99964						
9961, to 9969	-	-	-	-	Bristol multiple spline screwdrivers (9)	-
99125, 99811	-	-	-	-	Slotted screwdrivers	-
99250, 99312						
99820, 99821, 99822	-	-	-	-	Phillips screwdrivers	-
9938	037103483126	-	-	-	Reamer	6
99X5	037103482501	-	-	-	Extension	6

99PA50 Tool Kit

- Series 99® screwdriver and nutdriver set designed for use with cordless rechargeable screwdrivers
- Contains 12 most popular nutdriver and screwdriver sizes together with a power adapter (Xcelite® Catalog No. 99PA)
- Convenient vinyl carrying pouch



Cat No.	UPC No.	Packed	Description	Diameter Inch	Shelf Pack
99PA50	037103497299	Boxed	Complete set	3/16	6
△ 99S8	037103482396	-	Stubby nutdriver	1/4	6
△ 99S10	037103482402	-	Stubby nutdriver	5/16	6
△ 99S12	037103482419	-	Stubby nutdriver	3/8	6
99PA	037103490926	-	Cordless screwdriver adapter	-	6

△ = Made to order, contact customer service for delivery.

Series 99® Compact Interchangeable-blade Sets

99PS40BP Ballpoint Allen hex socket type screwdriver set - Inch sizes

- Unique “ballpoint” tip ideal for tightening and removing Allen socket screws in hard to reach spots or need a quicker way to drive them home
- 9 blades 4"/101.60mm long, 99X5 extension and regular 991 handle in plastic see-through stand-up case
- Will engage screw head from any angle
- Ends precision-machined to close tolerances to help slip easily into sockets and hold securely without reaming

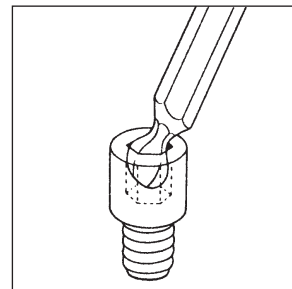

Cat No.	UPC No.	Packed	Tip Size Inch	Tool Length		Shelf Pack
				Inch	mm	
99PS40BP	037103482297	Boxed	Complete set	-	-	3
99PS40BPV	037103482303	Carded	Complete set carded	-	-	3
9920BP	037103482976	-	.050	4	102	6
9921BP	037103482990	-	1/16	4	102	6
9922BP	037103483010	-	5/64	4	102	6
9923BP	037103483034	-	3/32	4	102	6
99764BP	037103483430	-	7/64	4	102	6
9924BP	037103483058	-	1/8	4	102	6
99964BP	037103483553	-	9/64	4	102	6
9925BP	037103483072	-	5/32	4	102	0
9926BP	037103483096	-	3/16	4	102	6
991	037103482532	-	Regular handle	4	102	6
99X5	037103482501	-	Extension	4	102	6

99PS41MMBP Ballpoint Allen Hex Socket Type Screwdriver Set

Metric Sizes

- Interchangeable, Allen hex socket type
- Contains 7 drivers, 102mm 99X5 extension and regular 991 handle
- 102mm approximate working length
- Flexible plastic see-through stand-up case



Cat No.	UPC No.	Packed	Description	Tool Length		Shelf Pack
				Inch	mm	
99PS41MMBP	037103482327	Boxed	Complete set	-	-	3
991	037103482532	-	Regular handle	4	102	6
99X5	037103482501	-	Extension	4	102	6

99XTD7 Torx® Screwdriver Blade Kit

- Interchangeable blades
- Contains 6 blades 4"/102mm long and regular 991 handle
- 102mm approximate working length



Cat No.	UPC No.	Packed	Tip Size	Tool Length		Shelf Pack
				Inch	mm	
99XTD7	037103490018	Boxed	Complete set	-	-	6
9910XTD	037103490025	-	T-10	4	102	6
9915XTD	037103490032	-	T-15	4	102	6
9920XTD	037103490049	-	T-20	4	102	6
9925XTD	037103490056	-	T-25	4	102	6
9927XTD	037103490063	-	T-27	4	102	6
9930XTD	037103490070	-	T-30	4	102	6
991	037103482532	-	Regular Handle	-	-	6

99PS40 Allen Hex Socket Type Screwdriver Set

Inch Sizes



- 11-piece set
- See-through plastic case

Cat No.	UPC No.	Packed	Diameter Inch	Tool Length		Shelf Pack
				Inch	mm	
99PS40	037103482273	Boxed	Complete set	-	-	3
99PS40V	037103482280	Carded	Complete set carded	-	-	3
991	037103482532	-	Regular handle	-	-	6
9920	037103482969	-	.050	4	102	6
9921	037103482983	-	1/16	4	102	6
9922	037103483003	-	5/64	4	102	6
9923	037103483027	-	3/32	4	102	6
99764	037103483102	-	7/64	4	102	6
9924	037103483041	-	1/8	4	102	6
99964	037103483119	-	9/64	4	102	6
9925	037103483065	-	5/32	4	102	6
9926	037103483089	-	3/16	4	102	6
99X5	037103482501	-	Extension	4	102	6

99PS41MM Allen Hex Socket Type Screwdriver Set

Metric Sizes



- Compact interchangeable blades
- Fits socket screws shown below
- 99X5 extension adds 102mm in length
- 991 handle 27mm x 105mm in length
- 102mm approximate working length
- Convenient see-through stand-up plastic case

Cat No.	UPC No.	Packed	Diameter mm	Socket head cap screws	Flat head cap screws	Diameter mm	Shelf Pack
				Set screws mm	thread diameter mm		
99PS41MM	037103482310	Boxed	Complete set	-	-	-	3
9971MM	037103483232	-	1.27	2.6	1.4	-	6
9972MM	037103483249	-	1.5	3	1.7, 2	-	6
9973MM	037103483256	-	2	4	2.3, 2.6	3	6
9974MM	037103483263	-	2.5	5	3	4	6
9975MM	037103483270	-	3	6	4	5	6
9976MM	037103483287	-	4	8	5	6	6
9977MM	037103483294	-	5	10	6	8	6
991	037103482532	-	-	Regular handle	-	-	6
99X5	037103482501	-	-	Extension	-	-	6

99PS50 Screwdriver and Nutdriver Set

- 13-piece set
- See-through stand-up plastic case

Inch Sizes



Cat No.	UPC No.	Packed	Description	Blade Diameter Inch	Tool Length		Shelf Pack
					Inch	mm	
99PS50	037103482334	Boxed	Complete set	-	-	-	3
99PS50V	037103482341	Carded	Complete set carded	-	-	-	3
996	037103482693	-	Regular nutdriver	3/16	3 5/8	92	6
997	037103482716	-	Regular nutdriver	7/32	3 5/8	92	6
998	037103482747	-	Regular nutdriver	1/4	3 5/8	92	6
999	037103482792	-	Regular nutdriver	9/32	3 5/8	92	6
9910	037103482822	-	Regular nutdriver	5/16	3 5/8	92	6
9911	037103482853	-	Regular nutdriver	11/32	3 5/8	92	6
9912	037103482884	-	Regular nutdriver	3/8	3 5/8	92	6
99811	037103483447	-	Slotted screwdriver	3/16	3 7/8	98	6
99250	037103483393	-	Slotted screwdriver	1/4	3 7/8	98	6
99821	037103483485	-	Phillips screwdriver	No. 1	4	102	6
99822	037103483508	-	Phillips screwdriver	No. 2	4	102	6
99X5	037103482501	-	Extension	-	4	102	6
991	037103482532	-	Regular handle	-	4	102	6

99PS51MM Compact, Interchangeable Shank, Nutdriver Set

- 12-piece set
- Convenient see-through stand-up plastic case

Metric Sizes



Cat No.	UPC No.	Packed	Approx. working Diameter mm	Hex head cap screws thread length mm	Hex nuts thread diameter mm	Diameter mm	Shelf Pack
99PS51MM	037103482358	Boxed	Complete set	-	-	-	3
994MM	037103482617	-	4	92	-	2	6
9945MM	037103482624	-	4.5	92	-	2.3	6
995MM	037103482662	-	5	92	2.6	2.6	6
9955MM	037103482679	-	5.5	92	3	3	6
996MM	037103482686	-	6	92	3.5	3.5	6
997MM	037103482723	-	7	92	4	4	6
998MM	037103482761	-	8	92	5	5	6
999MM	037103482808	-	9	92	-	-	6
9910MM	037103482839	-	10	102	6	6	6
9911MM	037103482860	-	11	102	7	7	6
991	037103482532	-	Regular handle	102	-	-	6
99X5	037103482501	-	Extension	102	-	-	6

99PS60 Bristol Multiple-spline Socket Type Screwdriver Set

Inch Sizes



- 11-piece set
- Convenient see-through stand-up plastic case

Cat No.	UPC No.	Packed	Diameter mm	Tool Length		Shelf Pack
				Inch	mm	
99PS60	037103482372	Boxed	Complete set	-	-	3
9961	037103483140	-	.048	4	102	6
9962	037103483157	-	.060	4	102	6
9963	037103483164	-	.069	4	102	6
9964	037103483171	-	.072	4	102	6
9966	037103483195	-	.096	4	102	6
△ 9967	037103483201	-	.111	4	102	6
△ 9969	037103483225	-	.183	4	102	6
991	037103482532	-	Regular handle	4	102	6
99X5	037103482501	-	Extension	4	102	6

△ = Made to order, contact customer service for delivery.

Electronic Assembly Tools Plier Selection Information

General

When selecting electronic cutting pliers, you should attempt to minimize your cost per cut by selecting the proper tool for each application. The type of cut, cutting area access, cutting edge quality and user preference will influence your choice.

Type of Cut

Electronic pliers are available with cutting edge angles that produce standard, semi-flush and flush cuts. These terms refer to the amount of "pinch" left on the tip of a wire after it has been cut

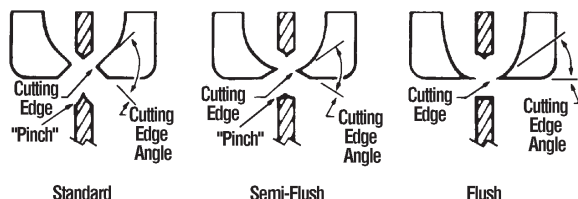

Standard cutting edges should be used for applications that are not sensitive to either the amount of shock transmitted through the wire to the component (during cutting) or to the amount of "pinch" left on the wire tip (after cutting).

Semi-flush edges can be employed for most applications. They reduce shock transmittal and wire tip "pinch."

Flush edges should be selected only for delicate applications, which require minimal shock transmittal and wire tip "pinch." Flush cutters produce a clean cut, which facilitates soldering and increases connection reliability. With small cutting edge angles, the life of flush cutters is substantially less than that of semi-flush cutters. The larger the cutting edge angle, the more cuts you can expect from the tool. For electronic assembly work, the semi-flush cutter is often the most cost-effective choice.

Cutting Area Access

Access to cutting areas can determine the shape and thickness of the cutting head. Tight clearances around the cutting area, the need to reach over in-place components or to work from directly above, and visibility requirements are all factors which will affect your choice of a tool. However, it is important to recognize that head shape and thickness are directly related to cutting edge life



Head Shape

Always select a cutter with the largest head that will meet your particular cutting requirements. It is a proven fact that more material behind the cutting edges gives more cuts and longer life.

Oval head cutters are the most versatile. They have the most material behind the cutting edges, and last longest. Tapered and angled head cutters should be selected only when access to the cutting area is limited. These cutters have less head mass, and provide proportionally fewer cuts.

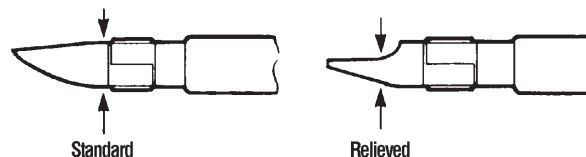

Head Thickness

Head thickness is related to cutting life in the same way as head shape. Cutting pliers with thicker heads also last longer. Whenever possible, use pliers with standard head thickness. Relieved head designs should be chosen only to accommodate difficult access problems.

Cutting Edge Quality

The quality of a pair of cutting pliers can be determined by visual inspection. The blades should meet smoothly and evenly at the tips. From a point just behind the tips to the joint, an increasing amount of light should be visible



A precision tip interface assures clean cutting of fine wires, while the "no contact" area behind the tips extends cutter life by allowing the tips to continue to meet as they wear.

User Preference

Other considerations can be a matter of personal preference. Handle shape, grip color, grip material, spring tension and leverage ratio are usually related to user comfort.

Proper spring tension will allow pliers to open and close with minimum effort. Finally, pliers with high leverage ratios provide the greatest ease of use and the longest life.

Leverage Ratio

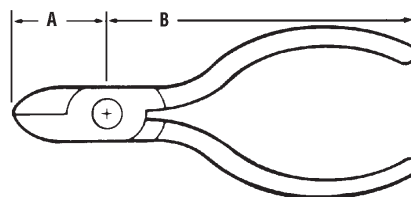

Leverage ratio is obtained by dividing dimension A into dimension B.

Cutting capability guide

* Maximum Tensile Strength

Catalog Number	Flush Edge	Semi-Flush Edge	Standard Edge	36 Ga. (.005) Teflon Coated Copper Wire	25 Ga. (.017) Soft Copper Wire	22 Ga. (.025) Soft Copper Wire	20 Ga. (.034) *90,000 PSI Steel Wire	20 Ga. (.034) *120,000 PSI Steel Wire	18 Ga. (.047) *200,000 PSI Steel Wire
EC54J	•				•	•	•		
EGA54J	•				•	•	•		
EMS543J	•				•	•	•		
EMS549J	•				•	•	•		
EMS54		•				•		•	
GA54J	•				•	•	•		
LC665J	•				•	•	•		
MS54			•				•		•
MS543J	•				•	•	•		
MS545		•				•		•	
MS545J	•				•	•	•		
MS549J	•				•	•	•		
S1415NJS	•				•	•	•		
S424NJS	•				•	•	•		
S54N				•			•		•
S54NKS		•				•		•	
S54NS			•			•			•
S55N				•			•		•
S55NKS		•				•		•	
S55NS			•			•			•
SN54			•				•		•
SN55			•				•		•
TC55			•				•		•

Xcelite® Electronic Pliers

Provide the ultimate in precision plier

- Manufactured to the highest professional quality
- Easily handles a wide range of electronic assembly requirements
- Smooth, easy-working, corrosion-proof joint
- Maintains perfect cutting edge and tip alignment
- All Xcelite® cutters and pliers are standard with ESD safe cushion grip handles. Exception: red grip products

Xcelite® Diagonal Cutting Pliers

FLUSH OR SEMI-FLUSH CUTTING EDGES HANDLE MOST CUTTING REQUIREMENTS

CUTTING EDGES MACHINE GROUND AND ELECTRONICALLY HARDENED FOR EXTENDED LIFE

FORGED ALLOY STEEL WITH POLISHED HEAD FOR HIGH DURABILITY

STEEL RIVIT FOR SMOOTH OPERATION AND LONG LIFE

HANDLE COIL SPRINGS FOR FAST CUTTING ACTION (Standard on all Models)

ESD SAFE CUSHION GRIPS FOR MAXIMUM COMFORT (Standard on all Models)

"ACCU-LITE" GRIPS ALSO AVAILABLE ON MANY MODELS



Pliers Features and Benefits

- Lightweight, miniature plier line. Includes versatile selection of diagonal, angular, tip and end cutters plus wiring and assembly tools.
- Choice of oval, tapered, relieved and angled head designs for general or confined area cutting.
- Full flush or semi-flush cutting edges machine ground and electronically hardened for extended life in cutting either hard or soft wires.
- Needle nose styles include long, short, curved, flat and round to handle most forming, looping, twisting, insertion and pickup jobs.
- Steel joint maintains perfect cutting edge and tip alignment to maximize operational consistency and tool life.
- Handle coil springs, allow faster cutting action with reduced user fatigue.
- Forged from high quality alloy steel for maximum strength and durability.
- Precision ground to close tolerances, individually finished and tested to ensure exact fit of jaws.
- Polished heads with gun metal handles.

	⚠ WARNING Handles Are NOT Electrically Insulated Beyond ESD Protection
	⚠ AVERTISSEMENT Les manches ne sont pas isolés électriquement au-delà de la protection DES
	⚠ ADVERTENCIA El mango no es aislante más allá de la protección ESD

	⚠ WARNING	⚠ AVERTISSEMENT	⚠ ADVERTENCIA
	Risk Of Eye Injury Wear ANSI Approved Eye Protection	Risque de dommages d'oeil Protection d'oeil approuvée de l'usage A.N.S.I.	Riesgo de lesión del ojo Protección de ojo aprobada del desgaste ANSI



Accu-Lite Handles Meet The Optimum Criteria For Hand Tools:

THUMB FLAIR INCREASES TOOL CONTROL

EXCLUSIVE, SOFT, NON-SLIP FOAM GRIPS PROVIDE POSITIVE GRIPPING AND MAXIMUM COMFORT

IDENTICALLY FORMED HANDLES ALLOW EITHER RIGHT OR LEFT-HAND USE

ANTI-STATIC GRIP MATERIAL DISSIPATES STATIC CHARGES

SOIL RESISTANT SURFACE EXTENDS GRIP LIFE

CONCAVE CONFIGURATION DISPERSES GRIPPING PRESSURE

EXTENDED HANDLE PERMITS USE OF ALL FINGERS



- **Lightweight construction**
- **Extended handle length** allows even application of force from all four fingers.
- **Exclusive, smooth, soft foam cushion grips** are free of abrupt edges and finger indentations.
- **Grip material is non-slip and compressible** to allow positive gripping and to absorb mechanical shock.
- **Handle contours adaptable for either right or left-hand use.**



Oval Head Cutter - Semi-flush

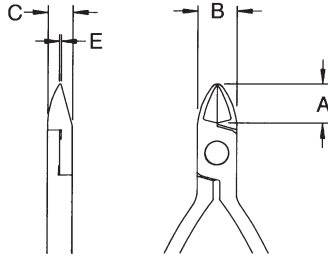

- Diagonal cutting pliers/semi-flush
- General-purpose cutting
- Oval head for long life
- Features green cushion grips

Cat No.	UPC No.	Packed	Length		A		B		C		E		Pack Wt.		Shelf Pack
			Inch	mm	Inch	mm	Inch	mm	Inch	mm	Inch	mm	lb	g	
MS54	043127069451	Bagged	4	100	13/32	10	7/16	11	9/32	7	1/32	.8	.78	354	6
MS54V	043127085444	Carded	4	100	13/32	10	7/16	11	9/32	7	1/32	.8	.78	354	6

Oval Head Cutter - Flush

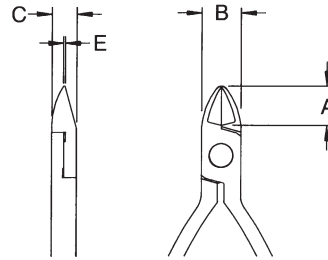

- Oval head diagonal cutter
- Flush cutting
- General use
- Features green cushion grips

Cat No.	UPC No.	Packed	Length		A		B		C		E		Pack Wt.		Shelf Pack
			Inch	mm	Inch	mm	Inch	mm	Inch	mm	Inch	mm	lb	g	
MS54J	043127160448	Bagged	4	100	13/32	10	7/16	11	9/32	7	1/32	.8	1.11	504	6

Tapered Head Diagonal Cutter

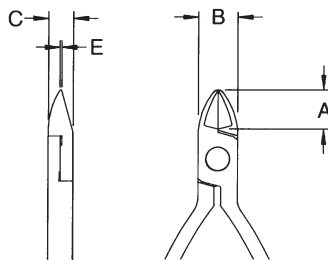

- Tapered head diagonal cutter
- Flush cutting of leads in restricted spaces
- Narrow tips give increased clearance
- Features green cushion grips

Cat No.	UPC No.	Packed	Length		A		B		C		E		Pack Wt.		Shelf Pack
			Inch	mm	Inch	mm	Inch	mm	Inch	mm	Inch	mm	lb	g	
MS549J	043127170508	Bagged	4	100	15/32	12	7/16	11	9/32	7	3/64	1	.96	435	6
MS549JV	043127085420	Carded	4	100	15/32	12	7/16	11	9/32	7	3/64	1	.96	435	6

Oval Head Diagonal Cutter

- Oval head diagonal cutter
- Semi-flush cutting
- General-purpose cutting of steel wires
- **Accu-Lite handles (see page 321)**

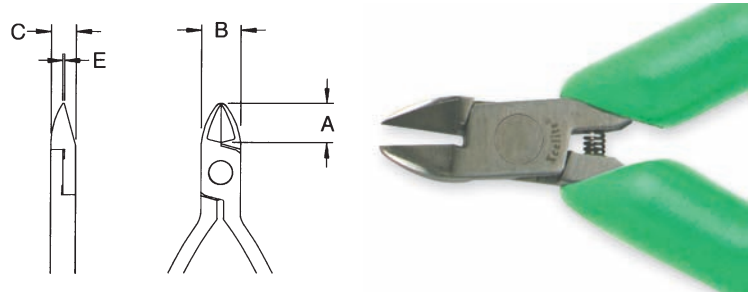

Cat No.	UPC No.	Packed	Length		A		B		C		E		Pack Wt.		Shelf Pack
			Inch	mm	Inch	mm	Inch	mm	Inch	mm	Inch	mm	lb	g	
EMS54	043127104374	Bagged	5 1/2	138	13/32	10	7/16	11	9/32	7	1/32	.8	.96	435	6

Tapered Head Diagonal Cutter

- Tapered head diagonal cutter
- Flush cutting
- **Accu-Lite handles (see page 321)**

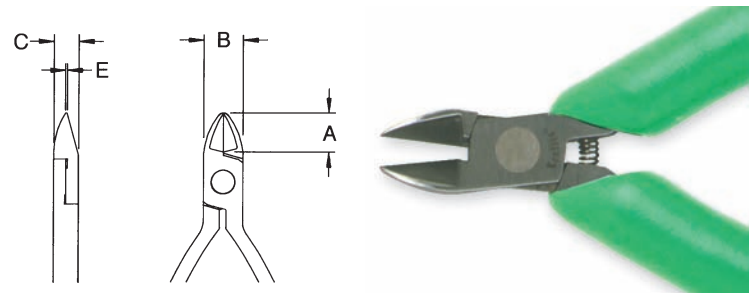

Cat No.	UPC No.	Packed	Length		A		B		C		E		Pack Wt.		Shelf Pack
			Inch	mm	Inch	mm	Inch	mm	Inch	mm	Inch	mm	lb	g	
EMS549J	043127104343	Bagged	5 1/2	138	15/32	12	7/16	11	9/32	7	3/64	1	.78	354	6

Relieved Tapered Head Cutter

- Diagonal cutting pliers
- Relieved tapered head-flush cutter
- Allows use between closely spaced components
- Features green cushion grips

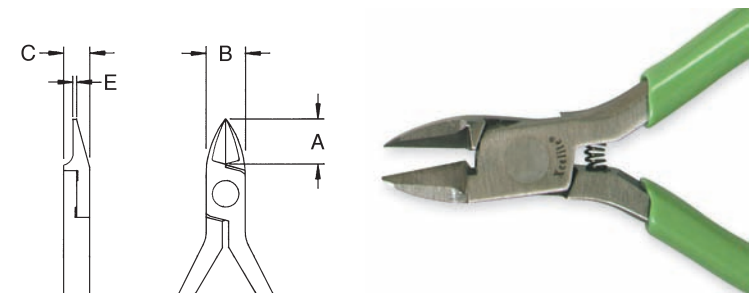

Cat No.	UPC No.	Packed	Length		A		B		C		E		Pack Wt.		Shelf Pack
			Inch	mm	Inch	mm	Inch	mm	Inch	mm	Inch	mm	lb	g	
MS543J	043127170676	Bagged	4	100	15/32	12	7/16	11	9/32	7	3/64	1	.78	354	6
MS543JV	037103129086	Carded	4	100	15/32	12	7/16	11	9/32	7	3/64	1	.78	354	6

Relieved Tapered Head Diagonal Cutter

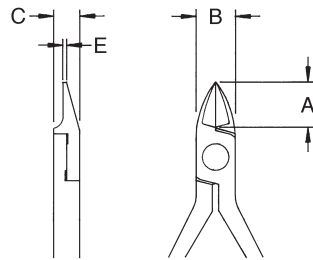
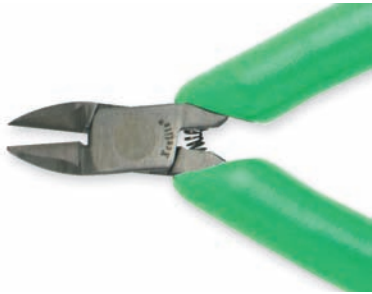

- Relieved tapered head diagonal cutter
- Flush cutting
- Clears closely spaced components
- **Accu-Lite handles (see page 321)**

Cat No.	UPC No.	Packed	Length		A		B		C		E		Pack Wt.		Shelf Pack
			Inch	mm	Inch	mm	Inch	mm	Inch	mm	Inch	mm	lb	g	
EMS543J	043127104329	Bagged	5 1/2	138	15/32	12	7/16	11	9/32	7	3/64	1	.78	354	6

Slim Line Tapered Head Cutter

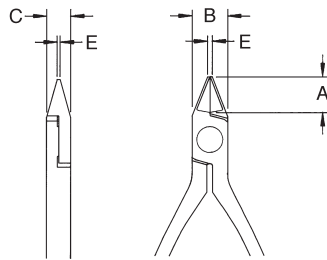

- Diagonal cutting pliers
- Slim line tapered head
- Semi-flush cutting
- Features green cushion grip

Cat No.	UPC No.	Packed	Length		A		B		C		E		Pack Wt.		Shelf Pack
			Inch	mm	Inch	mm	Inch	mm	Inch	mm	Inch	mm	lb	g	
MS545	043127069482	Bagged	4	100	13/32	10	7/16	11	9/32	7	1/16 x 1/32	1.5 x .9	.78	354	6
MS545V	037103129116	Carded	4	100	13/32	10	7/16	11	9/32	7	1/16 x 1/32	1.5 x .9	.96	435	6

Slim Line Tapered Head Cutter

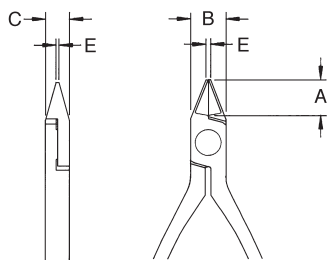

- Diagonal cutting pliers
- Slim line tapered head
- Flush cutting
- Features green cushion grips

Cat No.	UPC No.	Packed	Length		A		B		C		E		Pack Wt.		Shelf Pack
			Inch	mm	Inch	mm	Inch	mm	Inch	mm	Inch	mm	lb	g	
MS545J	043127170713	Bagged	4	100	13/32	10	7/16	11	9/32	7	1/16 x 1/32	1.5 x .9	1.01	458	6
MS545JV	043127086038	Carded	4	100	13/32	10	7/16	11	9/32	7	1/16 x 1/32	1.5 x .9	1.01	458	6

Slim Line Tapered Diagonal Cutter

- Slim line tapered diagonal cutter
- Flush cutting
- Allows use between closely spaced components
- **Accu-Lite handles** (see page 321)

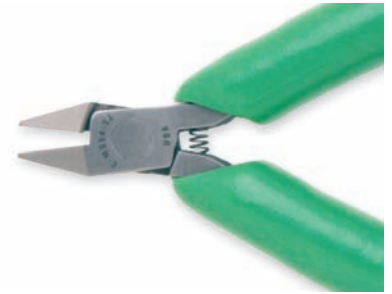
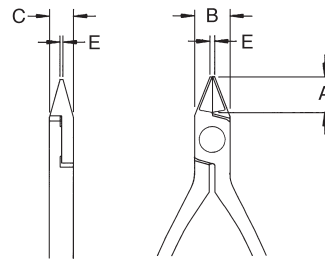

Cat No.	UPC No.	Packed	Length		A		B		C		E		Pack Wt.		Shelf Pack
			Inch	mm	Inch	mm	Inch	mm	Inch	mm	Inch	mm	lb	g	
EMS545J	043127104336	Bagged	5 1/2	138	13/32	10	7/16	11	9/32	7	1/32	.8	.78	354	6

Relieved Head Diagonal Cutter

- Relieved tapered head diagonal cutter
- Flush cutting
- For use in limited access areas
- Features green cushion grips

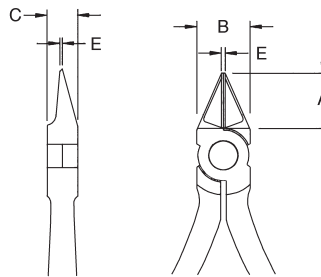

Cat No.	UPC No.	Packed	Length		A		B		C		E		Pack Wt.		Shelf Pack
			Inch	mm	Inch	mm	Inch	mm	Inch	mm	Inch	mm	lb	g	
S424NJS	037103213624	Boxed	4	100	5/8	16	37/64	15	5/16	8	3/64 x 1/32	1 x .8	1.33	603	6
S424NJSV	037103213631	Carded	4	100	5/8	16	37/64	15	5/16	8	3/64 x 1/32	1 x .8	1.33	603	6

Tapered Head Diagonal Cutter

- Tapered head diagonal cutter
- Flush cutting
- Used for cutting component leads
- Features green cushion grips

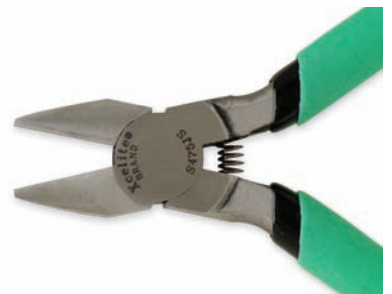
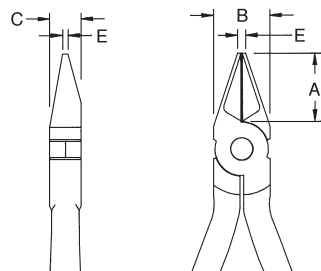

Cat No.	UPC No.	Packed	Length		A		B		C		E		Pack Wt.		Shelf Pack
			Inch	mm	Inch	mm	Inch	mm	Inch	mm	Inch	mm	lb	g	
S475NJS	037103213273	Bagged	5	125	3/4	19	19/32	15	3/8	10	3/32 x 1/16	2 x 1.5	1.47	667	6
S475NJSV	037103213228	Carded	5	125	3/4	19	19/32	15	3/8	10	3/32 x 1/16	2 x 1.5	1.47	667	6

Tapered Relieved Head Diagonal Cutter

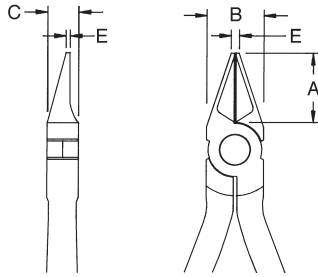

- Tapered relieved head diagonal cutter
- Flush cutting
- For use in limited access areas
- Features green cushion grips

Cat No.	UPC No.	Packed	Length		A		B		C		E		Pack Wt.		Shelf Pack
			Inch	mm	Inch	mm	Inch	mm	Inch	mm	lb	g			
S1415NJS	037103213235	Boxed	5	125	49/64	19	19/32	15	3/8	10	3/32 x 3/64	2 x 1	1.5	680	6

Diagonal Lead Cutter

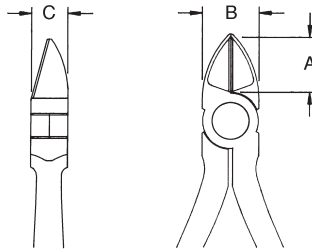

- Oval head
- Diagonal lead cutter
- Heavy-duty cutting
- Features green cushion grips
- S54S same as S54 plus handle coil spring

Cat No.	UPC No.	Packed	Length		A		B		C		Pack Wt.		Shelf Pack
			Inch	mm	Inch	mm	Inch	mm	Inch	mm	lb	g	
S54N	037103213648	Bagged	4 1/2	112	5/8	16	37/64	15	3/8	9	1.32	599	6
S54NS	037103213679	Bagged	4 1/2	112	5/8	16	37/64	15	3/8	9	1.32	599	6
S54NSV	037103213686	Carded	4 1/2	112	5/8	16	37/64	15	3/8	9	1.32	599	6

Diagonal Lead Cutter

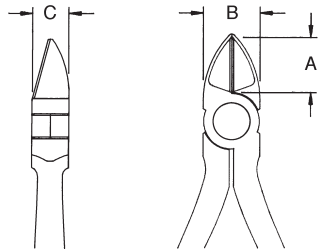

- Oval head
- Diagonal lead cutter with handle coil spring
- Heavy-duty cutting
- Semi-flush cutter
- Features green cushion grips

Cat No.	UPC No.	Packed	Length		A		B		C		Pack Wt.		Shelf Pack
			Inch	mm	Inch	mm	Inch	mm	lb	g			
S54NKS	037103213662	Bagged	4 1/2	112	5/8	16	37/64	15	3/8	9	1.32	599	6

Xcelite

Oval Head Diagonal Cutter

- Oval head diagonal cutter
- Regular beveled edge
- Features green cushion grips
- S55S same as S55 plus handle coil spring

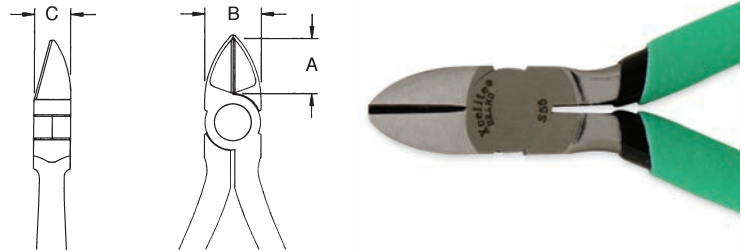

Cat No.	UPC No.	Packed	Length		A		B		C		Pack Wt.		Shelf Pack
			Inch	mm	Inch	mm	Inch	mm	Inch	mm	lb	g	
S55N	037103213242	Bagged	5	125	49/64	19	19/32	15	3/8	9	1.5	680	6
S55NS	037103213280	Bagged	5	125	49/64	19	19/32	15	3/8	9	1.5	680	6

Oval Head Diagonal Cutter

- Oval head diagonal cutter with handle coil spring
- Heavy-duty cutting
- Semi-flush cutter
- Features green cushion grips

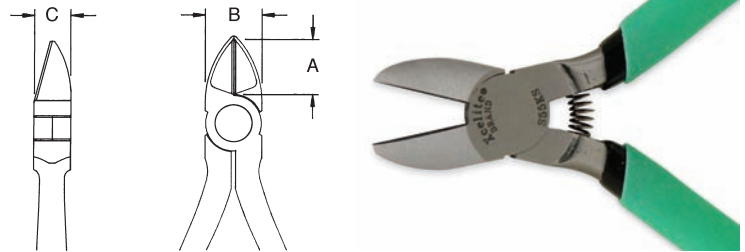

Cat No.	UPC No.	Packed	Length		A		B		C		Pack Wt.		Shelf Pack
			Inch	mm	Inch	mm	Inch	mm	Inch	mm	lb	g	
S55NKS	037103213259	Bagged	5	125	49/64	19	19/32	15	3/8	9	1.5	680	6

Xcelite

Xcelite® Diagonal End Cutter Pliers

Angled Diagonal End Cutter at 29°

- Angled diagonal end cutter at 29°
- Flush cutting
- For cutting directly above the work area
- To use on closely spaced adjacent components
- Features green cushion grips

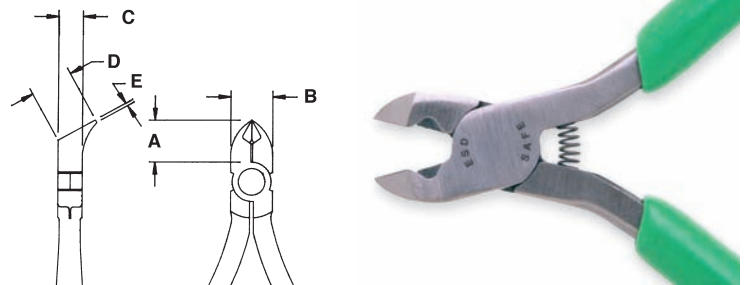

Cat No.	UPC No.	Packed	Length		A		B		C		D		E		Pack Wt.		Shelf Pack
			Inch	mm	Inch	mm	Inch	mm	Inch	mm	Inch	mm	Inch	mm	lb	g	
GA54J	043127170331	Bagged	4	100	7/16	11	7/16	11	9/32	7	7/16	11	1/32	.8	.96	454	6
GA54JV	043127085475	Carded	4	100	7/16	11	7/16	11	9/32	7	7/16	11	1/32	.8	.96	454	6

Angled Head Cutter

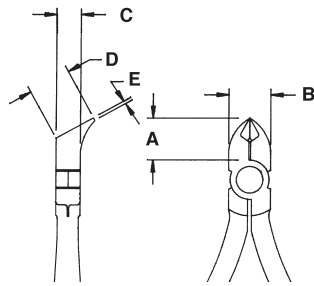
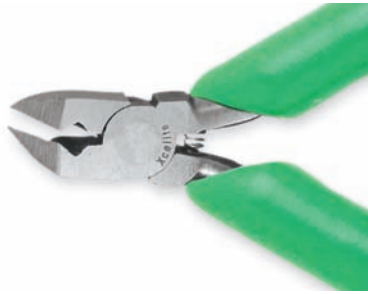

- Angled cutter
- Flush cutting edges
- Head angle allows cutting from above
- **Accu-Lite handles (see page 321)**

Cat No.	UPC No.	Packed	Length		A		B		C		D		E		Pack Wt.		Shelf Pack
			Inch	mm	Inch	mm	Inch	mm	Inch	mm	Inch	mm	Inch	mm	lb	g	
EGA54J	043127064197	Bagged	5 1/2	138	7/16	11	7/16	11	9/32	7	7/16	11	1/32	.8	.96	454	6

Transverse End Cutter

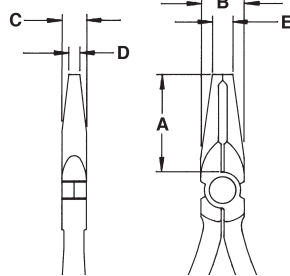
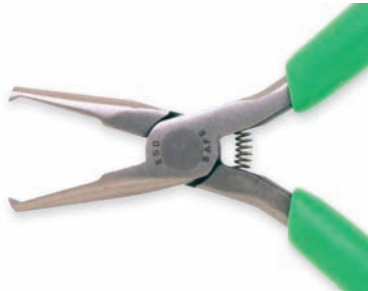

- Transverse end cutter
- Flush cutting edge
- Vertical cutting in tight spaces
- Features green cushion grips

Cat No.	UPC No.	Packed	Length		A		B		C		D		E		Pack Wt.		Shelf Pack
			Inch	mm	Inch	mm	Inch	mm	Inch	mm	Inch	mm	Inch	mm	lb	g	
EC54J	043127170096	Bagged	4 1/2	112	1	25	7/16	11	9/32	7	1/8	3	3/16	5	.78	354	6

30° Angled Tip Cutter

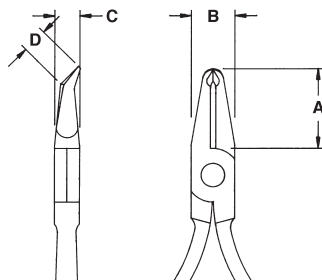

- 30° Angled tip cutter
- Flush cutting in dense areas
- Thin angled nose for high visibility
- Features green cushion grips

Cat No.	UPC No.	Packed	Length		A		B		C		D		Pack Wt.		Shelf Pack
			Inch	mm	Inch	mm	Inch	mm	Inch	mm	Inch	mm	lb	g	
LC665J	043127062742	Bagged	4 1/2	112	29/32	23	1/2	13	19/64	7	1/4	6	.96	454	6

Diagonal Chain Nose Pliers - Short Chain Nose Pliers

- Short chain nose pliers
- Serrated jaws
- Heavy-duty
- Features green cushion grips

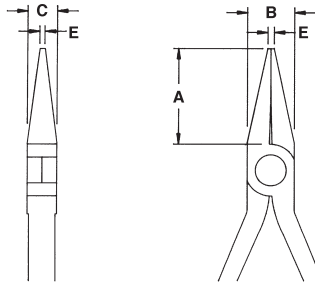

Cat No.	UPC No.	Packed	Length		A		B		C		E		Pack Wt.		Shelf Pack
			Inch	mm	Inch	mm	Inch	mm	Inch	mm	Inch	mm	lb	g	
LN225	043127063138	Bagged	5	125	1 9/64	29	17/32	14	9/32	7	1/16 x 1/16	1.5 x 1.5	1.14	517	6

60° Curved Nose Pliers

- Curved nose pliers
- Thin tip
- Features green cushion grips
- CN255G features smooth jaws
- CN255 features fine serrated jaws

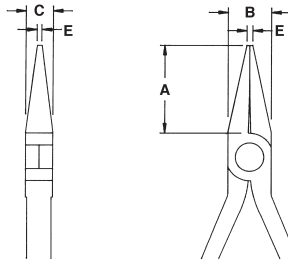

Cat No.	UPC No.	Packed	Length		A		B		C		E		Pack Wt.		Shelf Pack
			Inch	mm	Inch	mm	Inch	mm	Inch	mm	Inch	mm	lb	g	
CN255	043127063022	Bagged	5	125	1 15/64	31	27/64	11	9/32	7	3/64	1	.90	408	6
CN255V	037103129147	Carded	5	125	1 15/64	31	27/64	11	9/32	7	3/64	1	.90	408	6
CN255G	043127063091	Bagged	5	125	1 15/64	31	27/64	11	9/32	7	3/64	1	.90	408	6

Xcelite

Diagonal Long Needle Nose Pliers - Thin Long Nose Pliers

- Thin long nose pliers
- General-purpose use
- Serrated jaws
- For pick-up and wire forming
- Features green cushion grips
- LN54CS packaged on a clip strip merchandising wand

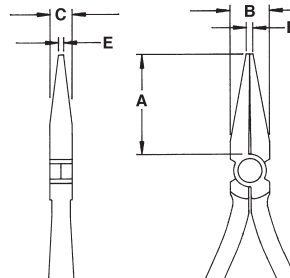

Cat No.	UPC No.	Packed	Length		A		B		C		E		Pack Wt.		Shelf Pack
			Inch	mm	Inch	mm	Inch	mm	Inch	mm	Inch	mm	lb	g	
LN54	043127170003	Bagged	5	125	1 3/16	30	7/16	11	9/32	7	5/64 x 1/16	2 x 1.6	.96	435	6
LN54V	043127085468	Carded	5	125	1 3/16	30	7/16	11	9/32	7	5/64 x 1/16	2 x 1.6	.96	435	6

Thin Long Nose Pliers - Fine Point

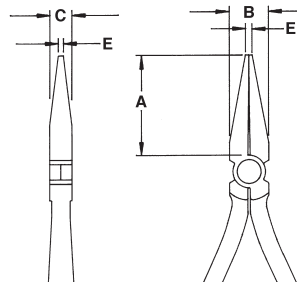

- Thin long nose pliers
- Fine point for precision work
- For pick-up and wire forming
- Serrated jaws
- Features green cushion grips

Cat No.	UPC No.	Packed	Length		A		B		C		E		Pack Wt.		Shelf Pack
			Inch	mm	Inch	mm	Inch	mm	Inch	mm	Inch	mm	lb	g	
LN542	043127170065	Bagged	5	125	1 3/16	30	7/16	11	9/32	7	3/64 x 1/32	1.2 x .8	.96	435	6

Thin Long Nose Pliers - Smooth Jaws

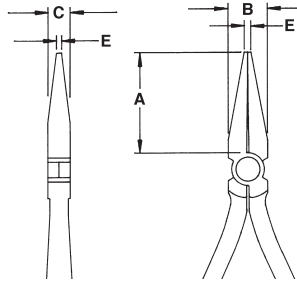

- Thin long nose pliers with smooth jaws
- General-purpose use
- For pick-up and wire forming
- Features green cushion grips

Cat No.	UPC No.	Packed	Length		A		B		C		E		Pack Wt.		Shelf Pack
			Inch	mm	Inch	mm	Inch	mm	Inch	mm	Inch	mm	lb	g	
LN54G	043127170027	Bagged	5	125	1 3/16	30	7/16	11	9/32	7	5/64 x 1/16	2 x 1.6	1.14	517	6
LN54GV	037103129154	Carded	5	125	1 3/16	30	7/16	11	9/32	7	5/64 x 1/16	2 x 1.6	1.14	517	6

Thin Long Nose Pliers

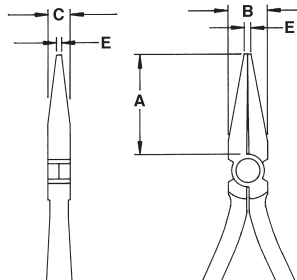

- Thin long nose pliers
- General-purpose use pick-up and wire forming
- ELN54 features fine serrated jaws
- ELN54G features smooth jaws
- **Accu-Lite handles (see page 321)**

Cat No.	UPC No.	Packed	Length		A		B		C		E		Pack Wt.		Shelf Pack
			Inch	mm	Inch	mm	Inch	mm	Inch	mm	Inch	mm	lb	g	
ELN54	043127170010	Bagged	6 1/2	163	1 3/16	30	7/16	11	9/32	7	5/64 x 1/16	2 x 1.6	.96	435	6
ELN54G	043127104350	Bagged	6 1/2	163	1 3/16	30	7/16	11	9/32	7	5/64 x 1/16	2 x 1.6	.96	435	6

Thin Long Nose Pliers

- Thin long nose pliers
- General-purpose
- Fine serrated jaws
- Features green cushion grips

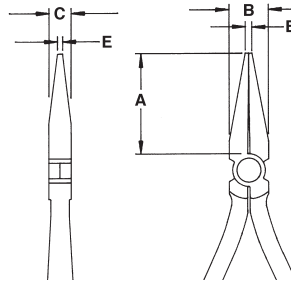

Cat No.	UPC No.	Packed	Length		A		B		C		E		Pack Wt.		Shelf Pack
			Inch	mm	Inch	mm	Inch	mm	Inch	mm	Inch	mm	lb	g	
LN55	043127068997	Bagged	5 1/2	138	1 11/16	43	17/32	14	9/32	7	5/64 x 1/16	2 x 1.6	1.5	680	6
LN55V	037103129161	Carded	5 1/2	138	1 11/16	43	17/32	14	9/32	7	5/64 x 1/16	2 x 1.6	1.5	680	6

Long Nose Side Cutting Pliers

- Long nose side cutting pliers
- For general wire applications
- For reaching into confined working spaces
- Serrated jaws
- Features green cushion grips

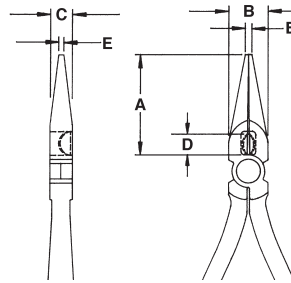

Cat No.	UPC No.	Packed	Length		A		B		C		D	E		Pack Wt.		Shelf Pack	
			Inch	mm	Inch	mm	Inch	mm	Inch	mm		lb	g				
SN54	043127170225	Bagged	5	125	1 3/16	30	17/32	14	9/32	7	1/4	6	5/64 x 1/16	2 x 1.6	.96	435	6
SN55	043127170249	Bagged	5 1/2	138	1 11/16	43	17/32	14	9/32	7	3/8	10	5/64 x 1/16	2 x 1.6	1.32	599	6
SN55V	037103129185	Carded	5 1/2	138	1 11/16	43	17/32	14	9/32	7	3/8	10	5/64 x 1/16	2 x 1.6	1.32	599	6

Wiring Pliers with Tip Cutter

- Wiring pliers with tip cutter
- Long nose
- Features green cushion grips

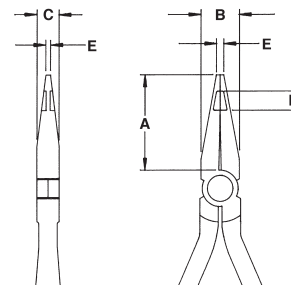

Cat No.	UPC No.	Packed	Length		A		B		C		D	E		Pack Wt.		Shelf Pack	
			Inch	mm	Inch	mm	Inch	mm	Inch	mm		lb	g				
TC55	043127070587	Bagged	5 1/2	138	1 1/4	32	17/32	14	9/32	7	1/4	6.4	3/32 x 1/16	2.4 x 1.6	1.33	603	6

60° Curved Long Nose Pliers

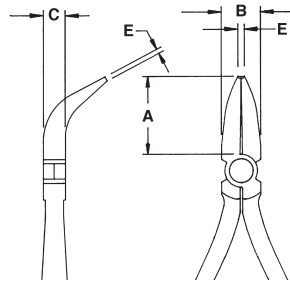

- 60° curved long nose pliers
- Smooth jaws
- For reaching between closely spaced components
- Features green cushion grips

Cat No.	UPC No.	Packed	Length		A		B		C		E		Pack Wt.		Shelf Pack
			Inch	mm	Inch	mm	Inch	mm	Inch	mm	Inch	mm	lb	g	
CN54G	043127170423	Bagged	5	125	15/16	24	7/16	11	9/32	7	5/64 x 1/16	2 x 1.6	1.14	517	6

45° Curved Long Nose Pliers

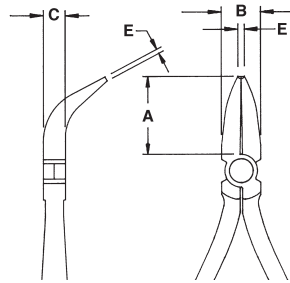

- 45° curved long nose pliers
- Smooth jaws
- For reaching over assembled components in confined areas
- Features green cushion grips

Cat No.	UPC No.	Packed	Length		A		B		C		E		Pack Wt.		Shelf Pack
			Inch	mm	Inch	mm	Inch	mm	Inch	mm	Inch	mm	lb	g	
CN55G	043127170140	Bagged	5 1/2	138	1 9/16	40	7/32	14	9/32	7	5/64 x 1/16	2 x 1.6	1.5	680	6

Round Nose Pliers

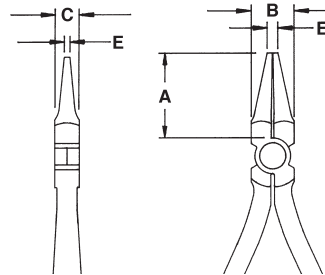

- Round nose pliers
- Round, smooth jaws tapered to point
- For looping and forming of fine wire
- Features green cushion grips

Cat No.	UPC No.	Packed	Length		A		B		C		E		Pack Wt.		Shelf Pack
			Inch	mm	Inch	mm	Inch	mm	Inch	mm	Inch	mm	lb	g	
RN54	043127170966	Bagged	4 1/2	113	7/8	22	7/16	11	9/32	7	1/8 x 1/16	3 x 1.6	.96	435	6

Flat Nose Pliers

- Flat nose pliers
- Smooth jaws
- For holding and forming wire and small parts
- Features green cushion grips

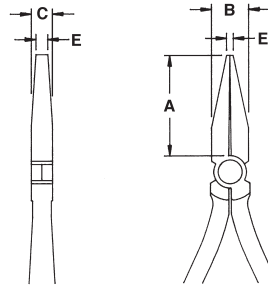

Cat No.	UPC No.	Packed	Length		A		B		C		E		Pack Wt.		Shelf Pack
			Inch	mm	Inch	mm	Inch	mm	Inch	mm	Inch	mm	lb	g	
DN54G	043127170461	Bagged	5	125	1 3/16	30	7/16	11	9/32	7	5/64 x 9/64	2 x 3.6	1.11	504	6
DN54GV	037103129093	Carded	5	125	1 3/16	30	7/16	11	9/32	7	5/64 x 9/64	2 x 3.6	1.11	504	6

Subminiature Needle Nose Pliers

- Subminiature needle nose pliers
- Positive gripping of fine wire or subminiature components
- Fine point allows use in confined areas
- L4 features serrated jaws
- L4G features smooth jaws
- Features green cushion grips
- L4CS packaged on a clip strip merchandising wand

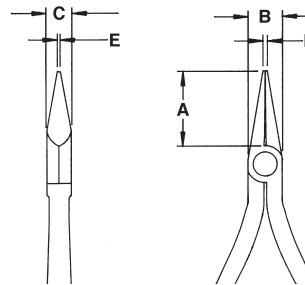

Cat No.	UPC No.	Packed	Length		A		B		C		E		Pack Wt.		Shelf Pack
			Inch	mm	Inch	mm	Inch	mm	Inch	mm	Inch	mm	lb	g	
L4	043127161049	Bagged	4	100	13/16	21	3/8	10	9/32	7	3/64 x 1/32	1.2 x .8	.78	354	6
L4V	043127085482	Carded	4	100	13/16	21	3/8	10	9/32	7	3/64 x 1/32	1.2 x .8	.78	354	6
L4G	043127161056	Bagged	4	100	13/16	21	3/8	10	9/32	7	3/64 x 1/32	1.2 x .8	.78	354	6

Xcelite

Fine Point Needle Nose Pliers

- Fine point needle nose pliers
- Positive gripping of fine wires or subminiature components
- Long, thin nose with fine serrated jaws
- Features green cushion grips

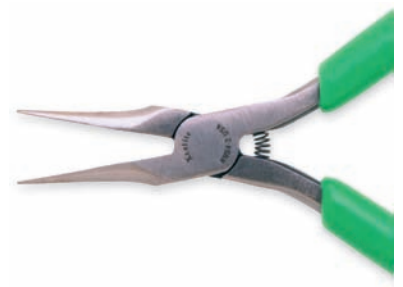
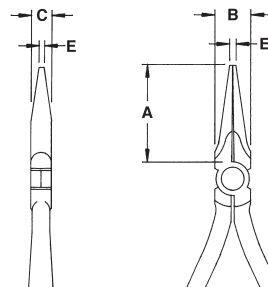

Cat No.	UPC No.	Packed	Length		A		B		C		E		Pack Wt.		Shelf Pack
			Inch	mm	Inch	mm	Inch	mm	Inch	mm	Inch	mm	lb	g	
NN542	043127170126	Bagged	5	125	1 3/16	30	7/16	11	9/32	7	3/64 x 1/32	1.2 x .8	.96	435	6

Slim Line Needle Nose Pliers

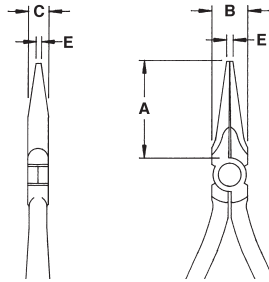

- Slim line needle nose pliers
- For use between tightly spaced components
- NN54, NN55, feature serrated jaws
- NN54G, NN55G feature smooth jaws
- Features green cushion grips

Cat No.	UPC No.	Packed	Length		A		B		C		E		Pack Wt.		Shelf Pack
			Inch	mm	Inch	mm	Inch	mm	Inch	mm	Inch	mm	lb	g	
NN54	043127170898	Bagged	5	125	1 3/16	30	7/16	11	9/32	7	5/64 x 1/16	2 x 1.6	.96	435	6
NN54V	043127089499	Carded	5	125	1 3/16	30	7/16	11	9/32	7	5/64 x 1/16	2 x 1.6	.96	435	6
NN54G	043127170911	Bagged	5	125	1 3/16	30	7/16	11	9/32	7	5/64 x 1/16	2 x 1.6	.96	435	6
NN54GV	037103129130	Carded	5	125	1 3/16	30	7/16	11	9/32	7	5/64 x 1/16	2 x 1.6	.96	435	6
NN55	043127170669	Bagged	5 1/2	138	1 11/16	43	15/32	12	1/4	6	5/64 x 1/16	2 x 1.6	1.32	5.99	6
NN55V	037103129468	Carded	5 1/2	138	1 11/16	43	15/32	12	1/4	6	5/64 x 1/16	2 x 1.6	1.32	5.99	6
NN55G	043127170935	Bagged	5 1/2	138	1 11/16	43	15/32	12	1/4	6	5/64 x 1/16	2 x 1.6	1.32	5.99	6

Fine Point Needle Nose Pliers

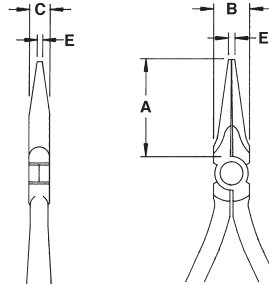

- Fine point needle nose pliers
- Positive gripping of fine wires or subminiature components
- Long, thin nose with fine serrated jaws
- **Accu-Lite handles (see page 321)**

Cat No.	UPC No.	Packed	Length		A		B		C		E		Pack Wt.		Shelf Pack
			Inch	mm	Inch	mm	Inch	mm	Inch	mm	Inch	mm	lb	g	
ENN54	043127170904	Bagged	6 1/2	163	1 3/16	30	7/16	11	9/32	7	5/64 x 1/16	2 x 1.6	.96	435	6

Long Nose Wiring and Pick-up Pliers

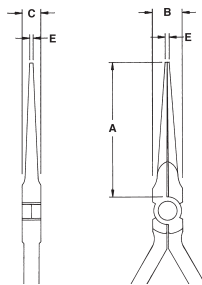

- Wiring and pick-up pliers
- With alignment pin
- Long nose design
- Features green cushion grips
- Serrated jaws

Cat No.	UPC No.	Packed	Length		A		B		C		E		Pack Wt.		Shelf Pack
			Inch	mm	Inch	mm	Inch	mm	Inch	mm	lb	g			
LN774512	043127063077	Bagged	5 1/2	138	1 3/4	45	15/32	12	1/4	6	5/64 x 1/16	2 x 1.5	1.08	490	6

Xcelite

Slim Line Long Needle Nose Pliers

- Slim line needle nose pliers
- Fine tip
- LN775512 features serrated jaws
- LN775512G features smooth jaws
- Features green cushion grips

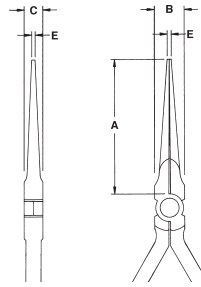

Cat No.	UPC No.	Packed	Length		A		B		C		E		Pack Wt.		Shelf Pack
			Inch	mm	Inch	mm	Inch	mm	Inch	mm	Inch	mm	lb	g	
LN775512	043127063121	Bagged	5 1/2	138	1 3/4	45	15/32	12	1/4	6	5/64 x 1/16	2 x 1.5	1.14	517	6
LN775512V	037103129499	Carded	5 1/2	138	1 3/4	45	15/32	12	1/4	6	5/64 x 1/16	2 x 1.5	1.14	517	6
LN775512G	043127079665	Bagged	5 1/2	138	1 3/4	45	15/32	12	1/4	6	5/64 x 1/16	2 x 1.5	1.14	517	6

60° Curved Long Nose Pliers

- Curved long nose pliers
- For reaching into confined spaces
- Features green cushion grips

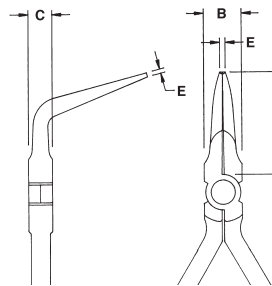

Cat No.	UPC No.	Packed	Length		A		B		C		E		Pack Wt.		Shelf Pack
			Inch	mm	Inch	mm	Inch	mm	Inch	mm	Inch	mm	lb	g	
CN7776	043127063060	Bagged	6	150	1 23/64	35	15/32	12	1/4	6	1/16 x 1/16	1.5 x 1.5	1.35	612	6

Long Needle Nose Pliers

- Long needle nose pliers
- Extra long nose
- NN7776 features serrated jaws
- NN7776G features smooth jaws
- Features green cushion grips

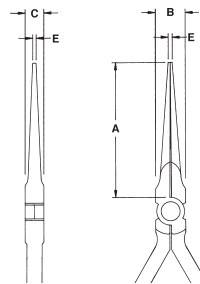

Cat No.	UPC No.	Packed	Length		A		B		C		E		Pack Wt.		Shelf Pack
			Inch	mm	Inch	mm	Inch	mm	Inch	mm	Inch	mm	lb	g	
NN7776	043127063008	Bagged	6	150	2 5/16	59	15/32	12	1/4	6	0.08 x 5/64	2 x 2	1.32	599	6
NN7776V	037103129482	Carded	6	150	2 5/16	59	15/32	12	1/4	6	0.08 x 5/64	2 x 2	1.32	599	6
NN7776G	043127083297	Bagged	6	150	2 5/16	59	15/32	12	1/4	6	0.08 x 5/64	2 x 2	1.32	599	6

Pliers Kit - Electronics Handy Pack Assortment



- A compact kit designed for the sophisticated electronics technician or dedicated hobbyist
- Consists of the six most popular Copaloy electronics pliers
- Durable pocket-pouch with heavy-duty snaps
- Each professional quality tool features the unique Copaloy rivet for smoother action

Kit Includes:

- EC54J 4 1/2" Transverse end cutting pliers
- MS54 4" Diagonal cutting pliers
- SN54 5" Long nose pliers with side cutter
- NN54 5" Fine tip needle nose pliers
- DN54G 5" Flat nose pliers
- LN54 5" Long nose pliers
- Pocket pouch with snaps

Cat No.	UPC No.	Description	Pack Wt.		Shelf Pack
			lb	g	
C1K	043127880179	6 pc. pliers kit	1	.45	1

Electronic Shearcutters and Pliers

Superior Quality and Value

- Xcelite's Shearcutter flush cutting tools require less than half the operator force of most wire and lead cutting tools and transmit proportionately less shock to the component
- As a result, they comply with MIL-STD-2000, DOD-STD-2000 and WS-6536E standards
- Grips are molded of wide, shock absorbing material for operator comfort
- Models 175 and 2178 incorporate safety clips which effectively eliminate flying leads
- However, safety glasses are still recommended when using these tools

Shear Cut

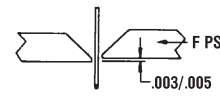

Total Operator

$$\text{Force} = \text{Less Than } 1/2 F$$

Crush Cut

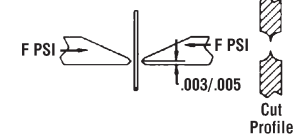

$$\text{Total Operator Force} = F$$

In shearcutting, one edge acts as an anvil while the other edge shears off the lead.



Shearcutter
170/175



Heavy-Duty
Shearcutter
1178/2178



Plier
378

Product features



Shearcutter — Red grips (Suffix "M")

- Advanced handle design
- Made from high quality carbon steel
- Non-glare black finish
- Superior shearing action



Static-dissipative pliers — black grips (Suffix "D")

- Advanced handle design
- Specially hardened and plated
- Non-glare black finish
- Superior shearing action



"ESD" Safe

Shearcutter - General-purpose

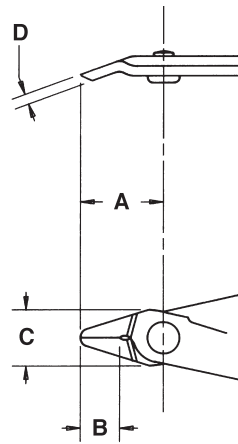

- Low profile, general-purpose cutter
- Superior blade by-pass shear cutting action
- Better cuts with half the effort
- Greatly reduced mechanical shock delivered to the work
- 170M, 175M feature light blue grips
- 170D, 175D feature static-dissipative black grips
- 175M, 175D feature safety clips
- 170D, 175D especially hardened and plated
- Flush cuts soft wire up to 20 AWG (0.8mm)
- 170MCS packaged on a clip strip merchandising wand

Safety Clip

Cat No.	UPC No.	Packed	Length		A		B		C		D		Pack Wt.		Shelf Pack
			Inch	mm	Inch	mm	Inch	mm	Inch	mm	Inch	mm	lb	g	
170M	037103029959	Carded	5	127	3/4	19	11/32	9	1/2	13	5/64	2	1.5	680	6
170D	037103029935	Carded	5	127	3/4	19	11/32	9	1/2	13	5/64	2	1.5	680	6
175M	037103030023	Carded	5	127	3/4	19	11/32	9	1/2	13	5/64	2	1.5	680	6
175D	037103030009	Carded	5	127	3/4	19	11/32	9	1/2	13	5/64	2	1.5	680	6

Shearcutter - Heavy-duty

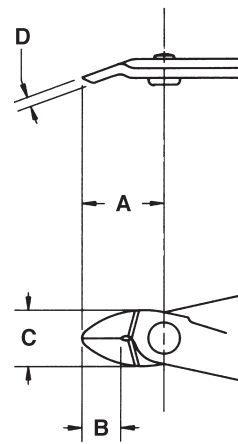

- Heavy-duty for IC pins, cables and harnesses
- Maximum durability
- Safety clip (on some models) prevents flying leads
- Maximum operator safety
- 1178M, 2178M feature light blue grips
- 1178D, 2178D feature static-dissipative black grips
- 2178M, 2178D feature safety clips
- 1178D, 2178D especially hardened and plated
- Flush cuts soft wire up to 14 AWG (1.6mm)

Safety Clip

Cat No.	UPC No.	Packed	Length		A		B		C		D		Pack Wt.		Shelf Pack
			Inch	mm	Inch	mm	Inch	mm	Inch	mm	Inch	mm	lb	g	
1178M	037103030825	Carded	5 5/8	143	29/32	23	13/32	10	17/32	14	1/8	3	1.62	735	6
1178D	037103030801	Carded	5 5/8	143	29/32	23	13/32	10	17/32	14	1/8	3	1.62	735	6
2178M	037103039590	Carded	5 5/8	143	29/32	23	13/32	10	17/32	14	1/8	3	1.62	735	6
2178D	037103031648	Carded	5 5/8	143	29/32	23	13/32	10	17/32	14	1/8	3	1.62	735	6

Xcelite

2 Piece Shearcutter / Plier Set

- The most popular all-purpose miniature electronic flush cutter and needle-nose plier
- Superior overall quality
- Advanced handle design
- Highest quality carbon steel
- Non-glare black finish
- Lightweight construction



Cat No.	UPC No.	Description	Pack Wt.		Shelf Pack
			lb	g	
S2K	043127131790	Carded	3.8	1724	10
			2 piece set (170M and 378M) 10 each sets/case cut pack		

Pliers - Serrated and Smooth Jaws

- Thin profile, long reach pliers
- For access into tight spaces
- Lightweight for maximum comfort
- For use in precision electronic assembly applications
- 378M, 378D feature serrated jaws
- 378SMM, 378SMD feature smooth jaws
- 378M, 378SMM feature light red grips
- 378D, 378SMD feature static-dissipative black grips and especially hardened and plated

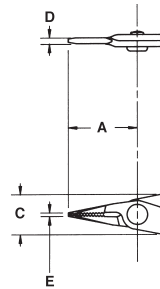

Cat No.	UPC No.	Packed	Length		A		C		D		E		Pack Wt.		Shelf Pack
			Inch	mm	Inch	mm	Inch	mm	Inch	mm	Inch	mm	lb	g	
378M	037103030252	Carded	5 1/2	140	1 1/2	32	17/32	14	1/8	3	3/64	1.2	1.62	735	6
378D	037103030238	Carded	5 1/2	140	1 1/2	32	17/32	14	1/8	3	3/64	1.2	1.62	735	6
378SMM	037103030320	Carded	5 1/2	140	1 1/2	32	17/32	14	1/8	3	3/64	1.2	1.62	735	6
378SMD	037103030306	Carded	5 1/2	140	1 1/2	32	17/32	14	1/8	3	3/64	1.2	1.62	735	6

Xcelite

Pliers and Cutters - With Red Cushion Grip Handles



- The exceptional strength and performance of Xcelite® pliers and cutters are the result of forged alloy steel construction, precision machining, and scientific proportioning
- Handles designed to fit the hand comfortably and to provide maximum leverage
- Cleanly machined and perfectly aligned jaws grip tightly and surely while easy cutting is assured by hand-honed, mated cutting edges
- For extra working comfort all models have permanent, red plastic-coated "Cushion-Grip" handles except Combination Slip Joint pliers
- These high quality pliers and cutters are featured in Xcelite® Attachê Tool Cases

	⚠ WARNING	⚠ AVERTISSEMENT	⚠ ADVERTENCIA
	Risk Of Eye Injury Wear ANSI Approved Eye Protection	Risque de dommages d'oeil Protection d'oeil approuvée de l'usage A.N.S.I.	Riesgo de lesión del ojo Protección de ojo aprobada del desgaste ANSI

Hard Wire (Piano and Music) Cutter 134CG

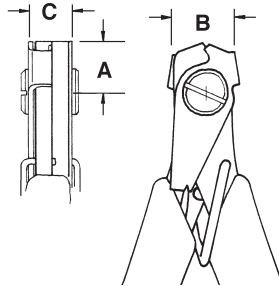

- Shear cutting action
- Ensures square cut ends
- Captures material on both sides of jaw, eliminates flying segments
- Patented spring loaded hold-down keeps material at 90° to tool blade
- Prevents material from forcing jaws apart
- Wire capacity .062
- Stranded cable capacity 1/16"

Xcelite

Cat No.	UPC No.	Packed	Length		A		B		C		Pack Wt.		Shelf Pack
			Inch	mm	Inch	mm	Inch	mm	Inch	mm	lb	g	
134CG	037103059994	Boxed	5.45	140	0.55	14	0.72	18.5	0.32	8.2	18.4	522	6

Diagonal Pliers 54CG

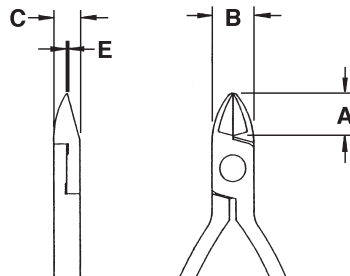

- For work in close quarters
- Oval head
- Standard beveled edges
- Forged alloy steel construction, precision machining and scientific proportioning
- Red plastic-coated cushion grip provides maximum leverage

Cat No.	UPC No.	Packed	Length		A		B		C		E		Pack Wt.		Shelf Pack
			Inch	mm	Inch	mm	Inch	mm	Inch	mm	Inch	mm	lb	g	
54CG	037103481580	Boxed	4	100	13/32	10	7/16	11	9/32	7	1/32	0.8	12.5	354	6
54CGV	037103481597	Carded	4	100	13/32	10	7/16	11	9/32	7	1/32	0.8	12.5	354	6

55NCG All Purpose Pliers

- All-purpose pliers
- Oval head
- Standard beveled edges
- Forged alloy steel construction, precision machining and scientific proportioning
- Exceptional strength and performance
- Red plastic-coated cushion grip provides maximum leverage

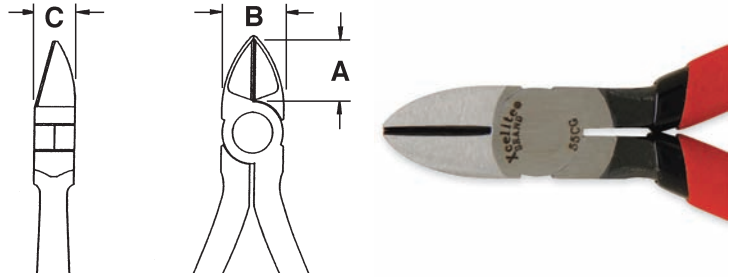

Cat No.	UPC No.	Packed	Length		A		B		C		E		Pack Wt.		Shelf Pack
			Inch	mm	Inch	mm	Inch	mm	Inch	mm	Inch	mm	lb	g	
55NCG	037103213297	Boxed	5	125	3/4	19	19/32	15	3/8	10	-	-	22.2	629	6
55NCGV	037103213327	Carded	5	125	3/4	19	19/32	15	3/8	10	-	-	22.2	629	6

64CG Semi-flush Tip Cutting Pliers

- For use in close quarters and semi-flush tip cutting of fine wires
- Forged alloy steel construction, precision machining and scientific proportioning
- Exceptional strength and performance
- Red plastic-coated cushion grip provides maximum leverage
- Tapered jaw

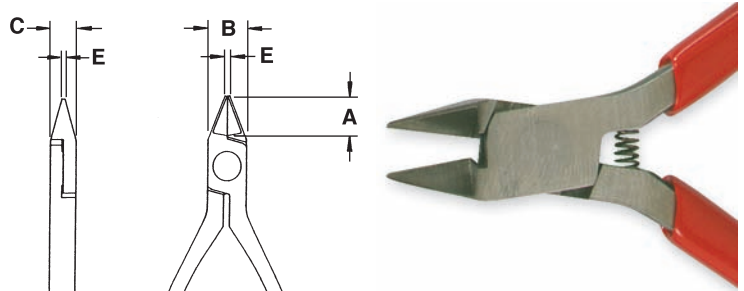

Cat No.	UPC No.	Packed	Length		A		B		C		E		Pack Wt.		Shelf Pack
			Inch	mm	Inch	mm	Inch	mm	Inch	mm	Inch	mm	lb	g	
64CG	037103481757	Boxed	4	100	13/32	10	7/16	11	9/32	7	1/32	0.8	12.5	354	6
64CGV	037103481764	Carded	4	100	13/32	10	7/16	11	9/32	7	1/32	0.8	12.5	354	6

66NCG All Purpose Pliers

- All-purpose pliers
- Oval head
- Standard beveled edges
- Forged alloy steel construction, precision machining and scientific proportioning
- Exceptional strength and performance
- Red plastic-coated cushion grip provides maximum leverage

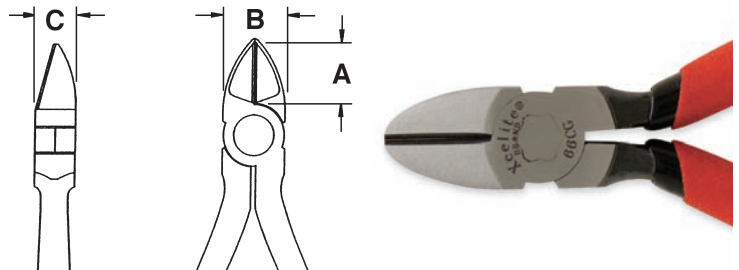

Cat No.	UPC No.	Packed	Length		A		B		C		E		Pack Wt.		Shelf Pack
			Inch	mm	Inch	mm	Inch	mm	Inch	mm	Inch	mm	lb	g	
66NCG	037103213457	Boxed	6	152	27/32	21	11/16	17	7/16	11	-	-	42.2	1196	6
66NCGV	037103213464	Carded	6	152	27/32	21	11/16	17	7/16	11	-	-	42.2	1196	6

57CG Standard Pliers

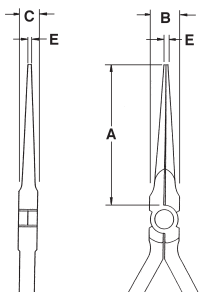

- Standard pliers
- For firm gripping and looping of wire
- Fine serrated jaw and coil spring
- Forged alloy steel construction, precision machining and scientific proportioning
- Red plastic-coated cushion grip provides maximum leverage

Cat No.	UPC No.	Packed	Length		A		B		C		E		Pack Wt.		Shelf Pack
			Inch	mm	Inch	mm	Inch	mm	Inch	mm	Inch	mm	lb	g	
57CG	037103481641	Boxed	5 11/16	144	-	-	15/32	12	1/4	6	5/64	2	20.8	590	6
57CGV	037103481658	Carded	5 11/16	144	-	-	15/32	12	1/4	6	5/64	2	20.8	590	6

51NCG, 52NCG Firm Gripping and Looping Pliers

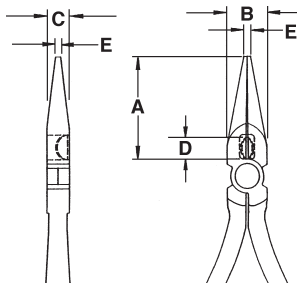

- For firm gripping and looping of wire
- Serrated jaw
- Forged alloy steel construction, precision machining and scientific proportioning
- Side cutter feature
- Red plastic-coated cushion grip provides maximum leverage
- 52NCGV without side cutter

Cat No.	UPC No.	Packed	Length		A		B		C		D		E		Pack Wt.		Shelf Pack
			Inch	mm	Inch	mm	Inch	mm	Inch	mm	Inch	mm	Inch	mm	lb	g	
51NCG	037103481528	Boxed	6	152	1 7/8	48	11/16	17	3/8	10	1/2	13	3/32	2.4	36.6	1038	6
51NCGV	037103212887	Carded	6	152	1 7/8	48	11/16	17	3/8	10	1/2	13	3/32	2.4	36.6	1038	6
52NCGV	037103212931	Carded	6	152	1 7/8	48	11/16	17	3/8	10	1/2	13	3/32	2.4	36.6	1038	6

59NCG Electrician's Chain Nose Pliers

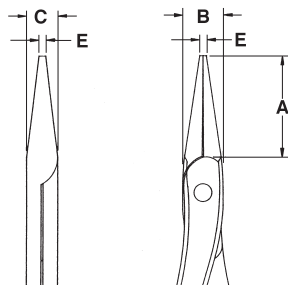

- Electrician's chain nose pliers
- Serrated jaw for gripping and high leverage
- Forged alloy steel construction, precision machining and scientific proportioning
- Offers long reach
- Red plastic-coated cushion grip provides maximum leverage

Cat No.	UPC No.	Packed	Length		A		B		C		E		Pack Wt.		Shelf Pack
			Inch	mm	Inch	mm	Inch	mm	Inch	mm	Inch	mm	lb	g	
59NCG	037103213730	Boxed	8	200	1 1/2	32	9/16	14	15/32	12	3/32	2.4	44.5	1262	6

Utility Pliers 50CG Ignition Pliers

- Ignition pliers
- Narrow jaw for close work
- 3-jaw opening adjustment to 1/2"
- Forged alloy steel construction, precision machining and scientific proportioning
- Red plastic-coated cushion grip provides maximum leverage



Cat No.	UPC No.	Packed	Length		Opening		Shelf Pack
			Inch	mm	Inch	mm	
50CG	037103481504	Boxed	5	127	1/2	12.7	6
50CGV	037103481511	Carded	5	127	1/2	12.7	6

Special Tools for Special Problems - Seizer

- Seizer forceps
- Versatile tool with unusual holding qualities
- Clamps firmly to hold wires for soldering
- Acts as a heat sink and retrieves small parts from hard-to-reach places
- Precision-machined from perfectly tempered stainless steel
- Box-joint construction
- 3-position snap lock
- Serrated jaws



Cat No.	UPC No.	Packed	Description	Length		Shelf Pack
				Inch	mm	
32H	037103481344	Boxed	Straight nose jr. seizer, smooth jaws	5.0	127	6
33HV	037103481375	Carded	Curved nose jr. seizer, smooth jaws	5.0	127	6
42HV	037103481412	Carded	Straight nose seizer, serrated jaws	5.5	140	6
43HV	037103481436	Carded	Curved nose seizer, serrated jaws	5.5	140	6

Xcelite

Wire Strippers & Cutters with Cushion Grip Handles 100X

- Cuts and strips both solid and stranded wire cleanly, neatly
- Adjustable screw stop for different wire sizes
- Hardened with ground blades
- 101S specifications same as 100X except with spring-equipped self-opening handles
- Red plastic-coated cushion grip provides maximum leverage



Cat No.	UPC No.	Packed	Description	Length		Shelf Pack
				Inch	mm	
100X	037103483560	Boxed	Stripper, cutter, 8 AWG - 22 AWG	5	127	6
100XV	037103483577	Carded	Stripper, cutter	5	127	6
101S	037103483584	Boxed	Stripper, cutter-spring opening	5	127	6
101SV	037103483591	Carded	Stripper, cutter-spring opening	5	127	6

103S Wire Stripper



- For industrial use
- Unique cam stop adjustment for different wire sizes, stays put even with screw loose
- Red plastic-coated cushion grip provides maximum leverage
- 8 - 22 AWG

Cat No.	UPC No.	Packed	Length		Shelf Pack
			Inch	mm	
103S	037103483607	Boxed	5 1/4	133	6
103SV	037103483614	Carded	5 1/4	133	6

104CG Wire Stripper and Cutter



- For copper and aluminum wire 10-22 AWG
- Wide size-range bolt cutter / Screw sizing stations
- Scissors-action, up-front wire cutting and wire stripping
- Pliers nose
- Hardened pivot joint bushing and crimp stations
- Red cushion grip handle provides maximum leverage
- 104CGCS packaged on a clip strip merchandising wand

Cat No.	UPC No.	Packed	Length		Shelf Pack
			Inch	mm	
104CG	037103486820	Boxed	8 1/4	210	6
104CGV	037103486837	Carded	8 1/4	210	6

105CG Electrical Pliers



- Wire cutting and stripping edges conveniently located in front of pivot to allow use in tight places
- Needle nose pliers add wire pulling and bending capabilities
- Scissors-action stripper for cleaner, faster and more accurate stripping
- Serrated edge
- Xcelite® Catalog No. 105SCGV includes work-speeding automatic spring and lock
- Red cushion grip handle provides maximum leverage
- For copper and aluminum wire 10-22 AWG

Cat No.	UPC No.	Packed	Description	Length		Shelf Pack
				Inch	mm	
105CG	037103486974	Boxed	Stripper, cutter without spring and lock	6	150	6
105CGV	037103486981	Carded	Stripper, cutter without spring and lock	6	150	6
105SCGV	037103487001	Carded	Stripper, cutter-spring opening and lock	6	150	6

Snips

- Shearing action of 1 1/2"/38mm cut pointed blades prevents peaks on fine wires and filaments
- Useful for removing insulation and cutting light sheet metal
- Coil spring opens blades
- Safety latch
- Red plastic-coated cushion grip provides maximum leverage



Cat No.	UPC No.	Packed	Length		Opening		Shelf Pack
			Inch	mm	Inch	mm	
86CG	037103482129	Boxed	6 1/2	165	1 1/2	38	6
86CGV	037103482136	Carded	6 1/2	165	1 1/2	38	6

XL70 Offset Ratchet Screwdriver Set

- 19-piece midsize, offset, reversible ratchet set
- All-purpose driver bits 1/4"/6mm hex shank
- Simple and easy-to-use for assembly, disassembly, adjustment and repair work involving Allen hex, Phillips® and slotted screws



Cat No.	UPC No.	Packed	Length		Description	Shelf Pack
			Inch	mm		
XL70	037103486691	Boxed	-	-	Complete set	1

XL75 Offset Ratchet Screwdriver Set

- 5-piece set
- Driver bits 1/4"/6mm hex shank
- See-through plastic pouch
- Slotted 3/16" - 1/4"
- Phillips® screw bit #1 and #2



Cat No.	UPC No.	Packed	Description	Shelf Pack
XL75	037103486707	Boxed	Complete set	1
XL75V	037103486714	Carded	Complete set vacuum packed	1

Adjustable Wrenches



- Rugged construction
- Quick, one-hand adjustment
- Chrome-plated, polished heads
- Cushion grip handle
- Red cushion grip handle provides maximum leverage

Cat No.	UPC No.	Packed	Length		Jaw Capacity		Shelf Pack
			Inch	mm	Inch	mm	
44CG	037103481443	Boxed	4	100	1/2	13	6
44CGV	037103481450	Carded	4	100	1/2	13	6
46CG	037103481467	Boxed	6	150	15/16	24	6
46CGV	037103481474	Carded	6	150	15/16	24	6
48CG	037103481481	Boxed	8	200	1 1/8	29	6
48CGV	037103481498	Carded	8	200	1 1/8	29	6

Electrician's Knife



- Both a knife and a screwdriver
- Screwdriver blade with sharp edge for scraping insulation
- Spear point

Cat No.	UPC No.	Packed	Description	Shelf Pack
K22	037103484239	Boxed	Electrician's knife	6
K22V	037103484246	Carded	Electrician's knife	6

Heat Sink



- Protects transistors and other delicate electronic components from heat during soldering
- Copper jaw for greatest possible heat absorption and dissipation (solder will not stick to finish)
- Nickel-plated finish
- Positive no-slip spring tension action
- Red plastic-coated cushion grip provides maximum leverage

Cat No.	UPC No.	Packed	Description	Length		Shelf Pack
				Inch	mm	
80V	037103482051	Carded	Heat sink	3 1/8	80	6

Premium Stainless Steel Tweezers - Made in U.S.A.

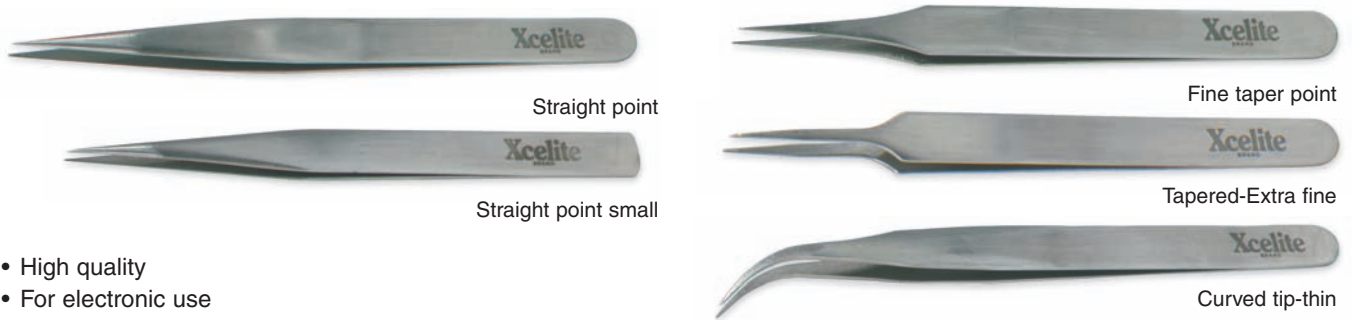

- High quality
- For electronic use
- Manufactured from anti-magnetic, anti-acid stainless steel
- Working tips hand finished for precise alignment
- Overall length is 4 1/2"
- Smooth jaws

Cat No.	UPC No.	Packed	Description	Shelf Pack
XSST3	037103490957	Boxed	Straight point	6
XSST3V	037103490964	Carded	Straight point carded	6
XSST3CV	037103490988	Carded	Straight point small carded	6
XSST4V	037103491008	Carded	Fine taper point carded	6
XSST5V	037103491022	Carded	Tapered-extra fine carded	6
XSST7V	037103491046	Carded	Curved tip-thin carded	6

General Duty Tweezers



Cat No.	UPC No.	Packed	Length		Description	Shelf Pack
			Inch	mm		
XHT434	037103487636	Boxed	4 3/4	121	Smooth sharp points	6
XHT412	037103487629	Boxed	4 1/2	115	Self closing, smooth sharp points for holding work	6
XHT612	037103487650	Boxed	6	165	Self closing, especially good for soldering and gluing	6
XHT678	037103487667	Boxed	6 7/8	174	For better view of close work for hard to reach places	6
XHT700	037103487674	Boxed	7	178	Slender tapered point to fit in tight places	6
XHT600	037103487643	Boxed	6	152	Serrated points for sure grips opens to 3/4" 19mm width	6

Precision Knives and Blades

- A fine selection of six knives from lightweight to heavy-duty for the professional and hobbyist
- Precision made for durable life
- Interchangeable blades held firm in sure-locking four jaw chuck
- Stay sharp blades are made from surgical steel and honed for closest cutting and long lasting edge

Light-duty Precision Knives



- Designed for light-duty cutting on paper, soft and light-weight materials or wood

Cat No.	UPC No.	Packed	Length		Type of blade	Shelf Pack
			Inch	mm		
XN100	037103487681	Boxed	5 13/16	148	XNB103	6
XN100B	037103488466	Boxed	Same as XN-100 – Tube			24

Medium-duty Precision Knife



- Designed for heavy paper and medium density materials

Cat No.	UPC No.	Packed	Length		Type of blade	Shelf Pack
			Inch	mm		
XN200	037103487698	Boxed	5 3/4	146	XNB205	6

Heavy-duty Plastic Handle Precision Knife



- Designed for working with hardwood, plastic and other difficult to cut materials

Cat No.	UPC No.	Packed	Length		Type of blade	Shelf Pack
			Inch	mm		
XN210	037103487704	Boxed	5 7/16	137	XNB201	6

Carving Precision Knife



- For those who prefer a metal handled knife
- Cuts through hardwood and plastics

Cat No.	UPC No.	Packed	Length		Type of blade	Shelf Pack
			Inch	mm		
XN300	037103487728	Boxed	5 5/8	144	XNB301	6

Light and Medium-duty Knife Set

- For a wide range of cutting operations
- Contains 10 assorted blades



Cat No.	UPC No.	Packed	Description	Shelf Pack
XNS100	037103487742	Boxed	XN100 and XN200 knives & 10 assorted blades	6

Replacement Blades

- Blades interchangeable with other similar knives
- Safely packed in transparent plastic containers and carded
- Bulk packed
- Number of blades per container shown in tables



XNB301 Straight Carving



XNB103 Fine Pointed



XNB205 Pointed



XNB305 Curved Carving



XNB203 General-Purpose



XNB201 Chisel



XNB105 Stencil



XNB101 Standard

Cat No.	UPC No.	Qty.	Description	Fits Knife	Shelf Pack
XNB103	037103487766	5	For most detailed cutting and stripping	XN100	6
XNB103B	037103488473	100	For most detailed cutting and stripping	XN100	1
XNB203	037103487797	5	For most cutting requirements	XN200/210/300	6
XNB105	037103487773	5	For scoring and etching as well as stencil cutting	XN100	6
XNB205	037103487803	5	For close corner cuts on templates, mates, gaskets, also trimming, stripping and de-burring	XN200/210/300	6
XNB201	037103487780	5	Rough shaping de-burring and chiseling	XN200/210/300	6
XNB101	037103487759	5	General-duty for cutting, carving and correcting stencils	XN100	6
XNB301	037103487834	2	For general-purpose carving	XN300	6
XNB305	037103487858	2	For smoothing and shaping	XN300	6

TKX11 Multi-purpose Tool Kit



- 11 quality tools perfect for all types of routine repair and simple DIY'er projects
- Packed neatly in an attractive easy-to-store case

Cat No.	UPC No.	Packed	Inch	mm	Description	Shelf Pack
TKX11	037103487377	Boxed	-	-	Complete tool kit	1
R144	037103485403	Boxed	1/4 x 4	101	Round blade screwdriver	-
R184	037103485496	Boxed	1/8 x 4	101	Round blade screwdriver	-
X101	037103486394	Boxed	No. 1 Phillips x 3	76	Round blade screwdriver	-
8	037103487001	Boxed	1/4	-	Hex nutdriver	-
P12S	037103484857	Boxed	No. 0 Phillips x 2	51	Screwdriver	-
51NCG	037103212856	Boxed	6	152	Long nose pliers with side cutter	-
46CG	037103481467	Boxed	6	152	Adjustable wrench	-
S141	037103485854	Boxed	1/4 x 11/4	32	Stubby square blade screwdriver	-
100X	037103483560	Boxed	-	-	Wire stripper & cut adj. screw top	-
W9210ME	037103458766	Boxed	1/2	13 x 10	3048mm Metric/English tape rule	-
76C	037103481986	Boxed	6	152	Combination plier, chrome plated	-

Model TCMB100STW and TCMB100MTW

The 100 Series Kits are all “The Largest and Most Elaborate”

- Contains 53 individual hand tools, 31 Series 99® interchangeable screwdriver/nutdriver blades and handles, and 2 specialized screwdriver/nutdriver kits (as listed)
- Extra large roller bearing wheels (3 5/8") with wide base for maximum stability and easy transport over rough pavement or stairs.
- Extra wide, comfortable extension handle is molded into case to prevent wear.
- Size: 18" x 15" x 8" deep.
- Extension handle locks in place automatically when extended and retracted. Easy one-handed release.
- Two tote handles for convenience. Both are spring loaded for protection.
- “D” ring provided for Bunji cords to carry other cases on top
- Case is super tough, black polyethylene rotationally molded for maximum strength. Minimum wall thickness of 0.120".
- 3-panel hinged tool pallet in lid plus additional pallet in bottom.
- Extra large storage space for additional equipment.
- Extra large all new screen mesh literature/utility pocket.



Cat No.	UPC No.	Description
TCMB100STW	037103107787	Tool case with tools
TCMB100MTW	037103107794	Tool case only-NO TOOLS

Cat No.	Description	Qty.	Cat No.	Description	Qty.	Cat No.	Description	Qty.
991	Handle – regular	1	57CG	Needle nose pliers 5 1/2"/139mm	1	XST102	Phillips screwdriver	1
991R	Handle – regular ratchet	1	59NCG	Chain nose pliers 8"/203mm	1	P18	Hex socket screwdriver	1
994R	Handle – Tee ratchet	1	86CG	Electronic snips	1	P19	Hex socket screwdriver	1
99X5	Extension	1	103S	Wire stripper/cutter	1	HS6	Nutdriver—hollow shaft	1
99X10	Extension	1	K22	Electrician's knife	1	HS8	Nutdriver—hollow shaft	1
9938	Reamer	1	M60	Mini drivers	1	HS10	Nutdriver—hollow shaft	1
99125	Slotted screw blade	1	XL75	Offset ratchet screwdrivers	1	HS11	Nutdriver—hollow shaft	1
99250	Slotted screw blade	1	600	Combination screwdriver-nutdriver tool	1	HS12	Nutdriver—hollow shaft	1
99312	Slotted screw blade	1	SB1	Dual reversible screwdriver blade	1	HS14	Nutdriver—hollow shaft	1
99811	Slotted screw blade	1	R144	Slotted screwdriver	1	HS16	Nutdriver—hollow shaft	1
99820	Phillips screw blade	1	R146	Slotted screwdriver	1	HS18	Nutdriver—hollow shaft	1
99821	Phillips screw blade	1	R181	Slotted screwdriver	1	8M	Nutdriver—magnetic	1
99822	Phillips screw blade	1	R184	Slotted screwdriver	1	10M	Nutdriver—magnetic	1
9961 -69	Bristol 6-flute multi. spline blades (9)	1	R3164	Slotted screwdriver	1	P3	Midget nutdriver	1
9920 -26	Allen hex socket type blades (7)	1	R3166	Slotted screwdriver (insulated)	1	P4	Midget nutdriver	1
99764	Allen hex socket type blade	1	R3323	Slotted screwdriver	1	P5	Midget nutdriver	1
99964	Allen hex socket type blade	1	R5325	Slotted screwdriver	1	P6	Midget nutdriver	1
42H	Straight nose seizer	1	S388	Slotted screwdriver	1	P7	Midget nutdriver	1
46CG	Adjustable wrench 6"/152mm	1	S3161	Slotted screwdriver	1	P8	Midget nutdriver	1
50CG	Midget slip joint pliers 5"/127mm	1	S5161	Slotted screwdriver	1	P9	Midget nutdriver	1
51NCG	Long nose pliers 6"/152mm	1	S5166	Slotted screwdriver	1	P10	Midget nutdriver	1
53CG	Utility pliers 7"/178mm	1	SX101	Phillips screwdriver	1	P11	Midget nutdriver	1
54CG	Diagonal pliers 4"/101mm	1	XST100	Phillips screwdriver	1	P12	Midget nutdriver	1
66NCG	Diagonal pliers 6"/152mm	1	XST101	Phillips screwdriver	1	TA2	Torque amplifier handle	1

Xcelite

Model TC100ST and TC100MT



- Largest, most elaborate of tool cases
- Contains 53 individual hand tools, 31 Series 99® interchangeable screwdriver/nutdriver blades and handles, and 2 specialized screwdriver/nutdriver kits (as listed)
- Covered with attractive durable charcoal brown leather-grain Marvelon vinyl
- Removable 3-panel hinged tool pallet in lid plus additional pallet in bottom
- Solid brass hardware with anodized aluminum divider in bottom
- Size: 18 3/4" x 12 1/2" x 5 7/8"/476mm x 318mm x 149mm

Cat No.	UPC No.	Description
TC100ST	037103486271	Tool case with tools
TC100MT	037103486257	Tool case only-NO TOOLS

Cat No.	Description	Qty.	Cat No.	Description	Qty.	Cat No.	Description	Qty.
991	Handle – regular	1	57CG	Needle nose pliers 5 1/2"/139mm	1	XST102	Phillips screwdriver	1
991R	Handle – regular ratchet	1	59NCG	Chain nose pliers 8"/203mm	1	P18	Hex socket screwdriver	1
994R	Handle – Tee ratchet	1	86CG	Electronic snips	1	P19	Hex socket screwdriver	1
99X5	Extension	1	103S	Wire stripper/cutter	1	HS6	Nutdriver—hollow shaft	1
99X10	Extension	1	K22	Electrician's knife	1	HS8	Nutdriver—hollow shaft	1
9938	Reamer	1	M60	Mini drivers	1	HS10	Nutdriver—hollow shaft	1
99125	Slotted screw blade	1	XL75	Offset ratchet screwdrivers	1	HS11	Nutdriver—hollow shaft	1
99250	Slotted screw blade	1	600	Combination screwdriver-nutdriver tool	1	HS12	Nutdriver—hollow shaft	1
99312	Slotted screw blade	1	SB1	Dual reversible screwdriver blade	1	HS14	Nutdriver—hollow shaft	1
99811	Slotted screw blade	1	R144	Slotted screwdriver	1	HS16	Nutdriver—hollow shaft	1
99820	Phillips screw blade	1	R146	Slotted screwdriver	1	HS18	Nutdriver—hollow shaft	1
99821	Phillips screw blade	1	R181	Slotted screwdriver	1	8M	Nutdriver—magnetic	1
99822	Phillips screw blade	1	R184	Slotted screwdriver	1	10M	Nutdriver—magnetic	1
9961 - 69	Bristol 6-flute multi. spline blades (9)	1	R3164	Slotted screwdriver	1	P3	Midget nutdriver	1
9920 - 26	Allen hex socket type blades (7)	1	R3166	Slotted screwdriver (insulated)	1	P4	Midget nutdriver	1
99764	Allen hex socket type blade	1	R3323	Slotted screwdriver	1	P5	Midget nutdriver	1
99964	Allen hex socket type blade	1	R5325	Slotted screwdriver	1	P6	Midget nutdriver	1
42H	Straight nose seizer	1	S388	Slotted screwdriver	1	P7	Midget nutdriver	1
46CG	Adjustable wrench 6"/152mm	1	S3161	Slotted screwdriver	1	P8	Midget nutdriver	1
50CG	Midget slip joint pliers 5"/127mm	1	S5161	Slotted screwdriver	1	P9	Midget nutdriver	1
51NCG	Long nose pliers 6"/152mm	1	S5166	Slotted screwdriver	1	P10	Midget nutdriver	1
53CG	Utility pliers 7"/178mm	1	SX101	Phillips screwdriver	1	P11	Midget nutdriver	1
54CG	Diagonal pliers 4"/101mm	1	XST100	Phillips screwdriver	1	P12	Midget nutdriver	1
66NCG	Diagonal pliers 6"/152mm	1	XST101	Phillips screwdriver	1	TA2	Torque amplifier handle	1

Model TCA100ST

- Contains 53 individual hand tools, 31 Series 99® interchangeable screwdriver/nutdriver blades and handles, and 2 specialized screwdriver/nutdriver kits (as listed)
- Hi-tech aluminum tool case with smooth finish, keyless combination lock and chrome-plated latches
- Tongue and groove lid with rubber gasket ensures a positive seal from dirt or water
- Case with removable 3-panel hinged tool pallet in lid plus additional panel in bottom
- Size: 17 5/8" x 12 5/8" x 7 7/8"/448mm x 321mm x 200mm



Cat No.	UPC No.	Description
TCA100ST	037103491343	Tool case with tools

Cat No.	Description	Qty.	Cat No.	Description	Qty.	Cat No.	Description	Qty.
991	Handle – regular	1	57CG	Needle nose pliers 5 1/2"/139mm	1	XST102	Phillips screwdriver	1
991R	Handle – regular ratchet	1	59NCG	Chain nose pliers 8"/203mm	1	P18	Hex socket screwdriver	1
994R	Handle – Tee ratchet	1	86CG	Electronic snips	1	P19	Hex socket screwdriver	1
99X5	Extension	1	103S	Wire stripper/cutter	1	HS6	Nutdriver—hollow shaft	1
99X10	Extension	1	K22	Electrician's knife	1	HS8	Nutdriver—hollow shaft	1
9938	Reamer	1	M60	Mini drivers	1	HS10	Nutdriver—hollow shaft	1
99125	Slotted screw blade	1	XL75	Offset ratchet screwdrivers	1	HS11	Nutdriver—hollow shaft	1
99250	Slotted screw blade	1	600	Combination screwdriver-nutdriver tool	1	HS12	Nutdriver—hollow shaft	1
99312	Slotted screw blade	1	SB1	Dual reversible screwdriver blade	1	HS14	Nutdriver—hollow shaft	1
99811	Slotted screw blade	1	R144	Slotted screwdriver	1	HS16	Nutdriver—hollow shaft	1
99820	Phillips screw blade	1	R146	Slotted screwdriver	1	HS18	Nutdriver—hollow shaft	1
99821	Phillips screw blade	1	R181	Slotted screwdriver	1	8M	Nutdriver—magnetic	1
99822	Phillips screw blade	1	R184	Slotted screwdriver	1	10M	Nutdriver—magnetic	1
9961-69	Bristol 6-flute multi. spline blades (9)	1	R3164	Slotted screwdriver	1	P3	Midget nutdriver	1
9920-26	Allen hex socket type blades (7)	1	R3166	Slotted screwdriver (insulated)	1	P4	Midget nutdriver	1
99764	Allen hex socket type blade	1	R3323	Slotted screwdriver	1	P5	Midget nutdriver	1
99964	Allen hex socket type blade	1	R5325	Slotted screwdriver	1	P6	Midget nutdriver	1
42H	Straight nose seizer	1	S388	Slotted screwdriver	1	P7	Midget nutdriver	1
46CG	Adjustable wrench 6"/152mm	1	S3161	Slotted screwdriver	1	P8	Midget nutdriver	1
50CG	Midget slip joint pliers 5"/127mm	1	S5161	Slotted screwdriver	1	P9	Midget nutdriver	1
51NCG	Long nose pliers 6"/152mm	1	S5166	Slotted screwdriver	1	P10	Midget nutdriver	1
53CG	Utility pliers 7"/178mm	1	SX101	Phillips screwdriver	1	P11	Midget nutdriver	1
54CG	Diagonal pliers 4"/101mm	1	XST100	Phillips screwdriver	1	P12	Midget nutdriver	1
66NCG	Diagonal pliers 6"/152mm	1	XST101	Phillips screwdriver	1	TA2	Torque amplifier handle	1

Model TCMB100ST and TCMB100MT



- Contains 53 individual hand tools, 31 Series 99® interchangeable screwdriver/nutdriver blades and handles, and 2 specialized screwdriver/nutdriver kits (as listed)
- Contains 3-panel hinged tool pallet in lid plus additional pallet in bottom
- Super tough, black polyethylene with rich looking black anodized aluminum hardware
- Size: 17 3/4" x 12 5/8" x 5 3/4"/451mm x 321mm x 146mm

Cat No.	UPC No.	Description
TCMB100ST	037103491990	Tool case with tools
TCMB100MT	037103491206	Tool case only-NO TOOLS

Cat No.	Description	Qty.	Cat No.	Description	Qty.	Cat No.	Description	Qty.
991	Handle – regular	1	57CG	Needle nose pliers 5 1/2"/139mm	1	XST102	Phillips screwdriver	1
991R	Handle – regular ratchet	1	59NCG	Chain nose pliers 8"/203mm	1	P18	Hex socket screwdriver	1
994R	Handle – Tee ratchet	1	86CG	Electronic snips	1	P19	Hex socket screwdriver	1
99X5	Extension	1	103S	Wire stripper/cutter	1	HS6	Nutdriver—hollow shaft	1
99X10	Extension	1	K22	Electrician's knife	1	HS8	Nutdriver—hollow shaft	1
9938	Reamer	1	M60	Mini drivers	1	HS10	Nutdriver—hollow shaft	1
99125	Slotted screw blade	1	XL75	Offset ratchet screwdrivers	1	HS11	Nutdriver—hollow shaft	1
99250	Slotted screw blade	1	600	Combination screwdriver-nutdriver tool	1	HS12	Nutdriver—hollow shaft	1
99312	Slotted screw blade	1	SB1	Dual reversible screwdriver blade	1	HS14	Nutdriver—hollow shaft	1
99811	Slotted screw blade	1	R144	Slotted screwdriver	1	HS16	Nutdriver—hollow shaft	1
99820	Phillips screw blade	1	R146	Slotted screwdriver	1	HS18	Nutdriver—hollow shaft	1
99821	Phillips screw blade	1	R181	Slotted screwdriver	1	8M	Nutdriver—magnetic	1
99822	Phillips screw blade	1	R184	Slotted screwdriver	1	10M	Nutdriver—magnetic	1
9961-69	Bristol 6-flute multi. spline blades (9)	1	R3164	Slotted screwdriver	1	P3	Midget nutdriver	1
9920-26	Allen hex socket type blades (7)	1	R3166	Slotted screwdriver (insulated)	1	P4	Midget nutdriver	1
99764	Allen hex socket type blade	1	R3323	Slotted screwdriver	1	P5	Midget nutdriver	1
99964	Allen hex socket type blade	1	R5325	Slotted screwdriver	1	P6	Midget nutdriver	1
42H	Straight nose seizer	1	S388	Slotted screwdriver	1	P7	Midget nutdriver	1
46CG	Adjustable wrench 6"/152mm	1	S3161	Slotted screwdriver	1	P8	Midget nutdriver	1
50CG	Midget slip joint pliers 5"/127mm	1	S5161	Slotted screwdriver	1	P9	Midget nutdriver	1
51NCG	Long nose pliers 6"/152mm	1	S5166	Slotted screwdriver	1	P10	Midget nutdriver	1
53CG	Utility pliers 7"/178mm	1	SX101	Phillips screwdriver	1	P11	Midget nutdriver	1
54CG	Diagonal pliers 4"/101mm	1	XST100	Phillips screwdriver	1	P12	Midget nutdriver	1
66NCG	Diagonal pliers 6"/152mm	1	XST101	Phillips screwdriver	1	TA2	Torque amplifier handle	1

Model TCS100ST

- Contains 53 individual hand tools, 31 Series 99® interchangeable screwdriver/nutdriver blades and handles, and 2 specialized screwdriver/nutdriver kits (as listed)
- Case made from rugged Cordura® with dual heavy-duty zippers and soft leather wrapped handles
- Contains (on outside) 1 pocket on one side and 2 smaller pockets on opposite
- Size: 17" x 12" x 3 1/4"/432mm x 305mm x 83mm
- Cordura® is a registered trademark of DUPONT



Cat No.	UPC No.	Description
TCS100ST	037103491251	Tool case with tools

Cat No.	Description	Qty.	Cat No.	Description	Qty.	Cat No.	Description	Qty.
991	Handle – regular	1	57CG	Needle nose pliers 5 1/2"/139mm	1	XST102	Phillips screwdriver	1
991R	Handle – regular ratchet	1	59NCG	Chain nose pliers 8"/203mm	1	P18	Hex socket screwdriver	1
994R	Handle – Tee ratchet	1	86CG	Electronic snips	1	P19	Hex socket screwdriver	1
99X5	Extension	1	103S	Wire stripper/cutter	1	HS6	Nutdriver—hollow shaft	1
99X10	Extension	1	K22	Electrician's knife	1	HS8	Nutdriver—hollow shaft	1
9938	Reamer	1	M60	Mini drivers	1	HS10	Nutdriver—hollow shaft	1
99125	Slotted screw blade	1	XL75	Offset ratchet screwdrivers	1	HS11	Nutdriver—hollow shaft	1
99250	Slotted screw blade	1	600	Combination screwdriver-nutdriver tool	1	HS12	Nutdriver—hollow shaft	1
99312	Slotted screw blade	1	SB1	Dual reversible screwdriver blade	1	HS14	Nutdriver—hollow shaft	1
99811	Slotted screw blade	1	R144	Slotted screwdriver	1	HS16	Nutdriver—hollow shaft	1
99820	Phillips screw blade	1	R146	Slotted screwdriver	1	HS18	Nutdriver—hollow shaft	1
99821	Phillips screw blade	1	R181	Slotted screwdriver	1	8M	Nutdriver—magnetic	1
99822	Phillips screw blade	1	R184	Slotted screwdriver	1	10M	Nutdriver—magnetic	1
9961-69	Bristol 6-flute multi. spline blades (9)	1	R3164	Slotted screwdriver	1	P3	Midget nutdriver	1
9920-26	Allen hex socket type blades (7)	1	R3166	Slotted screwdriver (insulated)	1	P4	Midget nutdriver	1
99764	Allen hex socket type blade	1	R3323	Slotted screwdriver	1	P5	Midget nutdriver	1
99964	Allen hex socket type blade	1	R5325	Slotted screwdriver	1	P6	Midget nutdriver	1
42H	Straight nose seizer	1	S388	Slotted screwdriver	1	P7	Midget nutdriver	1
46CG	Adjustable wrench 6"/152mm	1	S3161	Slotted screwdriver	1	P8	Midget nutdriver	1
50CG	Midget slip joint pliers 5"/127mm	1	S5161	Slotted screwdriver	1	P9	Midget nutdriver	1
51NCG	Long nose pliers 6"/152mm	1	S5166	Slotted screwdriver	1	P10	Midget nutdriver	1
53CG	Utility pliers 7"/178mm	1	SX101	Phillips screwdriver	1	P11	Midget nutdriver	1
54CG	Diagonal pliers 4"/101mm	1	XST100	Phillips screwdriver	1	P12	Midget nutdriver	1
66NCG	Diagonal pliers 6"/152mm	1	XST101	Phillips screwdriver	1	TA2	Torque amplifier handle	1

Model TCA150ST



- Carefully selected, intermediate assortment of Xcelite® hand tools and WP25 Weller® 25 watt soldering iron
- Contains 23 individual hand tools, 24 Series 99® interchangeable screwdriver/nutdriver blades and handles, XL70 offset ratchet screwdriver set, measuring tape and solder (as listed)
- High tech aluminum tool case with smooth finish, keyless combination lock and chrome-plated latch
- Tongue and groove lid with rubber gasket ensures a positive seal from dirt or water
- Case complete with removable pallet in lid plus additional panel in bottom
- Size: 17 5/8" x 12 5/8" x 5 3/4"/448mm x 321mm x 146mm

Cat No.	UPC No.	Description
TCA150ST	037103491367	Tool case with tools

Cat No.	Description	Qty.	Cat No.	Description	Qty.	Cat No.	Description	Qty.
991, 994R	Handles (regular and ratchet Tee)	1	51NCG	Long nose pliers 6"/152mm	1	S5166	Slotted screwdriver	1
99X5	Extension	1	54CG	4"/102mm Diagonal	1	S3161	Slotted screwdriver	1
9920 - 26, 99764, 99964	Allen hex-socket type blades (9)	1	55NCG	5"/127mm Diagonal	1	SX101	Phillips screwdriver	1
996 - 12	Hex nutdriver blades (7)	1	57CG	5 1/2"/102mm Diagonal	1	XL75	5-piece set in see-thru plastic pouch	1
99250 & 99811	Screwdriver blades	1	59NCG	8"/203mm Chain nose pliers	1	600	Combination Dual Nutdriver Handle	1
99821 & 99822	Phillips screw blades	1	86CG	Electronic snips	1	W9210ME	10-foot tape	1
9938	Reamer	1	101S	Wire stripper	1	HS14	Hollow shaft	1
42H	Seizer	1	K22	Electrician's knife	1	HS16	Hollow shaft	1
46CG	Adjustable wrench	1	R181	Slotted screwdriver	1	8M	Magnetic	1
50CG	Midget slip joint pliers 5"/127mm	1	R3323	Slotted screwdriver	1	10M	Magnetic	1
53CG	7"/178mm Utility pliers	1	R184	Slotted screwdriver	1	WP25	Weller 25 watt soldering iron	1
			R3164	Slotted screwdriver	1			

Model TCMB150ST and TCMB150MT

- Carefully selected intermediate assortment of Xcelite® hand tools
- Contains 23 individual hand tools, popular WP25 Weller® 25 watt soldering iron, 24 Series 99® interchangeable screwdriver/nutdriver blades and handles, XL75 offset ratchet screwdriver set, measuring tape and solder (as listed)
- Super tough, black polyethylene with rich looking black anodized aluminum hardware
- Size: 17 3/4" x 12 5/8" x 4 3/4"/451mm x 321mm x 121mm



Cat No.	UPC No.	Description
TCMB150ST	037103491213	Tool case with tools
TCMB150MT	037103491220	Tool case only-NO TOOLS

Cat No.	Description	Qty.	Cat No.	Description	Qty.	Cat No.	Description	Qty.
991, 994R	Handles (regular and ratchet Tee)	1	51NCG	Long nose pliers 6"/152mm	1	S5166	Slotted screwdriver	1
99X5	Extension	1	54CG	4"/102mm Diagonal	1	S3161	Slotted screwdriver	1
9920 - 26,	Allen hex-socket type blades (9)	1	55NCG	5"/127mm Diagonal	1	SX101	Phillips screwdriver	1
99764, 99964			57CG	5 1/2"/102mm Diagonal	1	XL75	5-piece set in see-thru plastic pouch	1
996 - 12	Hex nutdriver blades (7)	1	59NCG	8"/203mm Chain nose pliers	1	600	Combination Dual Nutdriver Handle	1
99250 & 99811	Screwdriver blades	1	86CG	Electronic snips	1	W9210ME	10-foot tape	1
99821 & 99822	Phillips screw blades	1	101S	Wire stripper	1	HS14	Hollow shaft	1
9938	Reamer	1	K22	Electrician's knife	1	HS16	Hollow shaft	1
42H	Seizer	1	R181	Slotted screwdriver	1	8M	Magnetic	1
46CG	Adjustable wrench	1	R3323	Slotted screwdriver	1	10M	Magnetic	1
50CG	Midget slip joint pliers 5"/127mm	1	R184	Slotted screwdriver	1	WP25	Weller 25 watt soldering iron	1
53CG	7"/178mm Utility pliers	1	R3164	Slotted screwdriver	1			

Model TCMG150ST and TCMG150MT



- Carefully selected intermediate assortment of Xcelite® hand tools
- Contains 23 individual hand tools, popular WP25 Weller® 25 watt soldering iron, 24 Series 99® interchangeable screwdriver/nutdriver blades and handles, XL75 offset ratchet screwdriver set, measuring tape and solder (as listed)
- Durable, double skin blow-molded plastic case
- Size: 17 3/4" x 12 5/8" x 4 3/4"/451mm x 321mm x 121mm

Cat No.	UPC No.	Description
TCMG150ST	037103162755	Tool case with tools
TCMG150MT	037103162762	Tool case only-NO TOOLS

Cat No.	Description	Qty.	Cat No.	Description	Qty.	Cat No.	Description	Qty.
991, 994R	Handles (regular and ratchet Tee)	1	51NCG	Long nose pliers 6"/152mm	1	S5166	Slotted screwdriver	1
99X5	Extension	1	54CG	4"/102mm Diagonal	1	S3161	Slotted screwdriver	1
9920 - 26, 99764, 99964	Allen hex-socket type blades (9)	1	55NCG	5"/127mm Diagonal	1	SX101	Phillips screwdriver	1
996 - 12	Hex nutdriver blades (7)	1	57CG	5 1/2"/102mm Diagonal	1	XL75	5-piece set in see-thru plastic pouch	1
99250 & 99811	Screwdriver blades	1	59NCG	8"/203mm Chain nose pliers	1	600	Combination Dual Nutdriver Handle	1
99821 & 99822	Phillips screw blades	1	86CG	Electronic snips	1	W9210ME	10-foot tape	1
9938	Reamer	1	101S	Wire stripper	1	HS14	Hollow shaft	1
42H	Seizer	1	K22	Electrician's knife	1	HS16	Hollow shaft	1
46CG	Adjustable wrench	1	R181	Slotted screwdriver	1	8M	Magnetic	1
50CG	Midget slip joint pliers 5"/127mm	1	R3323	Slotted screwdriver	1	10M	Magnetic	1
53CG	7"/178mm Utility pliers	1	R184	Slotted screwdriver	1	WP25	Weller 25 watt soldering iron	1
			R3164	Slotted screwdriver	1			

Model TCS150ST and TCS150MT

- Carefully selected, intermediate assortment of Xcelite® hand tools
- Contains 23 individual hand tools, popular WP25 Weller® 25 watt soldering iron, 24 Series 99® interchangeable screwdriver / nutdriver blades and handles, XL75 offset ratchet screwdriver set, measuring tape and solder (as listed)
- Case made from rugged Cordura® with heavy-duty zipper and soft leather wrapped handles
- Contains (on outside) 1 pocket on 1 side and 2 smaller pockets on opposite
- Cordura® is a registered trademark of DUPONT
- Size: 17" x 12" X 3"/432mm x 305mm x 76mm



Cat No.	UPC No.	Description
TCS150ST	037103491275	Tool case with tools
TCS150MT	037103491282	Tool case only-NO TOOLS

Cat No.	Description	Qty.	Cat No.	Description	Qty.	Cat No.	Description	Qty.
991, 994R	Handles (regular and ratchet Tee)	1	51NCG	Long nose pliers 6"/152mm	1	S5166	Slotted screwdriver	1
99X5	Extension	1	54CG	4"/102mm Diagonal	1	S3161	Slotted screwdriver	1
9920 - 26,	Allen hex-socket type blades (9)	1	55NCG	5"/127mm Diagonal	1	SX101	Phillips screwdriver	1
99764, 99964			57CG	5 1/2"/102mm Diagonal	1	XL75	5-piece set in see-thru plastic pouch	1
996 - 12	Hex nutdriver blades (7)	1	59NCG	8"/203mm Chain nose pliers	1	600	Combination Dual Nutdriver Handle	1
99250 & 99811	Screwdriver blades	1	86CG	Electronic snips	1	W9210ME	10-foot tape	1
99821 & 99822	Phillips screw blades	1	101S	Wire stripper	1	HS14	Hollow shaft	1
9938	Reamer	1	K22	Electrician's knife	1	HS16	Hollow shaft	1
42H	Seizer	1	R181	Slotted screwdriver	1	8M	Magnetic	1
46CG	Adjustable wrench	1	R3323	Slotted screwdriver	1	10M	Magnetic	1
50CG	Midget slip joint pliers 5"/127mm	1	R184	Slotted screwdriver	1	WP25	Weller 25 watt soldering iron	1
53CG	7"/178mm Utility pliers	1	R3164	Slotted screwdriver	1			

Model TCS200ST



- Fine blending of quality, economy and flexibility
- Contains 10 individual hand tools and 27 Series 99® interchangeable screwdriver/nutdriver blades and handles (as listed)
- Case made from rugged Cordura® and features a heavy-duty zipper and soft leather wrapped handles
- Contains (on outside) 1 pocket on one side and 2 smaller pockets on opposite
- Size: 13 1/2" x 10 1/2" x 2 3/8"/343mm x 267mm x 60mm
- Cordura® is a registered trademark of DUPONT

Cat No.	UPC No.	Description
TCS200ST	037103490421	Tool case with tools

Cat No.	Description	Qty.	Cat No.	Description	Qty.	Cat No.	Description	Qty.
991	Straight handle	1	99811	Slotted screw blade	1	43H	Curved nose seizer 6"/152mm	1
994	Tee handle	1	99250	Slotted screw blade	1	46CG	Adjustable wrench 6"/152mm	1
9920 - 9926	Hex socket screw blades(7)	1	99312	Slotted screw blade	1	51NCG	Long nose pliers 6 1/2"/165mm	1
99764	Hex socket screw blade	1	996	Hex nutdriver blade	1	53CG	Utility pliers 7"/178mm	1
99964	Hex socket screw blade	1	998	Hex nutdriver blade	1	64CG	Diagonal pliers 4"/101mm	1
9938	Reamer	1	9910	Hex nutdriver blade	1	55NCG	Diagonal pliers 5"/127mm	1
99X5	Extension	1	9911	Hex nutdriver blade	1	57CG	Needle nose pliers 5 1/2"/139mm	1
99820	Phillips screw blade	1	9912	Hex nutdriver blade	1	86CG	Electronic snips	1
99821	Phillips screw blade	1	9914	Hex nutdriver blade	1	101S	Wire stripper-cutter	1
99822	Phillips screw blade	1	9916	Hex nutdriver blade	1	K22	Electrician's knife	1
99125	Slotted screw blade	1						

Model TCMG200ST

- Fine blending of quality, economy and flexibility
- Contains 10 individual hand tools and 27 Series 99® interchangeable screwdriver/nutdriver blades and handles (as listed)
- Durable, double skin blow-molded plastic case
- Size: 13 1/2" x 10 1/2" x 2 3/8"/343mm x 267mm x 60mm



Cat No.	UPC No.	Description
TCMG200ST	037103162731	Tool case with tools

Cat No.	Description	Qty.
991	Straight handle	1
994	Tee handle	1
9920 - 9926	Hex socket screw blades(7)	1
99764	Hex socket screw blade	1
99964	Hex socket screw blade	1
9938	Reamer	1
99X5	Extension	1
99820	Phillips screw blade	1
99821	Phillips screw blade	1
99822	Phillips screw blade	1
99125	Slotted screw blade	1

Cat No.	Description	Qty.
99811	Slotted screw blade	1
99250	Slotted screw blade	1
99312	Slotted screw blade	1
996	Hex nutdriver blade	1
998	Hex nutdriver blade	1
9910	Hex nutdriver blade	1
9911	Hex nutdriver blade	1
9912	Hex nutdriver blade	1
9914	Hex nutdriver blade	1
9916	Hex nutdriver blade	1

Cat No.	Description	Qty.
43H	Curved nose seizer 6"/152mm	1
46CG	Adjustable wrench 6"/152mm	1
51NCG	Long nose pliers 6 1/2"/165mm	1
53CG	Utility pliers 7"/178mm	1
64CG	Diagonal pliers 4"/101mm	1
55NCG	Diagonal pliers 5"/127mm	1
57CG	Needle nose pliers 5 1/2"/139mm	1
86CG	Electronic snips	1
101S	Wire stripper-cutter	1
K22	Electrician's knife	1

Tools for Cable Terminals and Connectors

Xcelite® ErgoCrimp Plus® Mechanical Crimping Tools

- ErgoCrimp Plus® are the world's most advanced crimping tools to date
- With a patented design, they deliver up to 50% better mechanical gain than any other kind
- With increased mechanical gain you will get significantly lower handle force which could result in an increase in productivity

These crimping tools have been designed to achieve maximum comfort, reliability, and durability.

Their main features are:

One-Handed Crimping

- The handle force needed for the crimping operation in most tools exceeds 60-70lbs. (27-32Kg)
- The average man and virtually all women cannot make a comfortable one-handed crimp
- Xcelite® crimping tools are designed with such a low handle force requirement that the crimp operation can be performed with only one hand

Crimping Pressure

- The configurations of the crimping nests and indentors are designed to increase the tensile strength of the crimp
- The jaw pressure applies is scientifically calculated for optimum connections

Reliability

- All components are made of high-quality Swedish steel and have been life tested for 50,000 cycles
- Precision manufacturing guarantees a uniform product of high accuracy
- After long wear, it is always possible to check the crimp dimensions with go/no-go gauges, and to adjust for eventual discrepancies by turning the patented excenter adjustment plate

Size

- Size has been minimized to allow single-handed operation and to ensure the tool fits easily into repair kits

Safety

- A ratchet device has been built in to guarantee that the user makes the exact same complete crimp every time
- Should the user start a faulty crimp, a safety release mechanism is built into the ratchet, allowing the user, with one finger, to open the tool before the cycle is complete

Economy

- Because of their considerable advantages in quality, speed, and efficiency, the payoff time for an investment in Xcelite® tools is extremely short

ErgoCrimp Plus® (ECP-000 Frame)
 Length: 10.0"
 Weight: 1.2lbs.

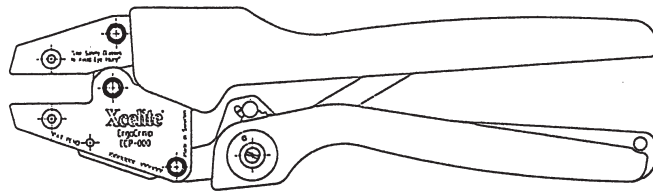

Xcelite

ErgoCrimp Plus® for 22-10 AWG Insulated Terminals and Splices



- ECP000 large ergonomic frame for large hands
- D100 die set for 22-10 AWG red, blue and yellow insulated terminals and splices
- Mechanical gain estimated 50%
- Guaranteed for at least 50,000 cycles
- Variety of die sets available



Cat No.	UPC No.	Packed	Description	Pack Wt.		Shelf Pack
				lb	kg	
ECP100	037103059307	Boxed	ECP000 frame and D100 die set	1.2	0.54	1
D100	037103059345	Boxed	Die set for ECP100	-	-	1

ErgoCrimp Plus® for 22-10 Non-Insulated Terminal Splices

- Die set designed for 22-10 AWG non-insulated terminal splices
- Patented ergonomic design makes this tool easy and comfortable to use
- Lowest possible handle forces required
- High quality construction with tight tolerances
- Superior crimp die design insures the highest quality crimp results
- High strength through-hardened alloy steel and precision manufacturing
- Guaranteed for 50,000 cycles
- Precise eccentric adjustment for consistent performance for life of tool
- Tools can be purchased complete with die set or separately
- Special dies are also available upon request



Cat No.	UPC No.	Packed	Description	Pack Wt.		Shelf Pack
				lb	kg	
ECP101	037103197146	Boxed	ECP101 frame and D101 die set	1.4	0.64	1

Frame only - ErgoCrimp Plus® Crimping Tool

- Large ergonomic frame for large hands
- Length 10"
- Width 2.83"
- Used with D100 through D109 die sets



Cat No.	UPC No.	Packed	Description	Pack Wt.		Shelf Pack
				lb	kg	
ECP000	037103059338	Boxed	ErgoCrimp Plus® crimping tool-large	1.00	0.45	1

Xcelite

ErgoCrimp® Die Set for Insulated Terminals and Splices

- For 22-10 AWG red, blue and yellow insulated terminals and splices
- Precision-machined hardened steel
- Fits ErgoCrimp® and ErgoCrimp Plus® tools



Cat No.	UPC No.	Packed	Description	Pack Wt.		Shelf Pack
				lb	kg	
D100	037103059345	Boxed	Die set			1

ErgoCrimp® Die Set for Non-insulated Terminals and Splices



- For 22-10 AWG non-insulated terminals and splices
- Precision-machined hardened steel
- Fits ErgoCrimp® and ErgoCrimp Plus® tools



Cat No.	UPC No.	Packed	Description	Shelf Pack
D101	037103059352	Boxed	Die set	1

ErgoCrimp® Die Set for RG58, RG59/62 AU BNC/TNC Coaxial Connectors



- For RG 58, RG 59/62 AU BNC/TNC - .213", .255" and .068" hex cavities
- Precision-machined hardened steel
- Fits ErgoCrimp® and ErgoCrimp Plus® tools

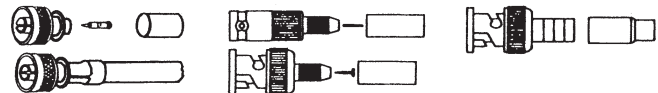

Cat No.	UPC No.	Packed	Description	Shelf Pack
D102	037103059369	Boxed	Die set	1

ErgoCrimp® Die Set for RG59, Belden® 8281 and Belden® 1694A, RG6, 50 and 75 ohm Coaxial Connectors



- For RG 59, Belden® 8281, RG6, 50 and 75 ohm center contacts - .324", .255", .068" and .042" hex cavities
- Precision-machined hardened steel
- Fits ErgoCrimp® and ErgoCrimp Plus® tools
- Belden® is a registered trademark of BELDEN, INC.

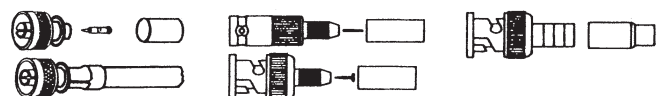

Cat No.	UPC No.	Packed	Description	Shelf Pack
D104	037103059383	Boxed	Die set	1

ErgoCrimp® Die Set for RG174, RG179 BNC/TNC Coaxial Connectors

- For RG 174 BNC/TNC - .178", .128", and .068" hex cavities
- Precision-machined hardened steel
- Fits ErgoCrimp® and ErgoCrimp Plus® tools

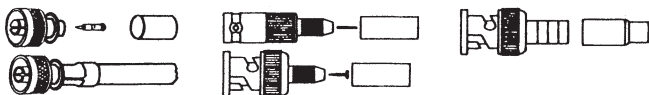

Cat No.	UPC No.	Packed	Description	Shelf Pack
D105	037103059390	Boxed	Die set	1

ErgoCrimp® Die Set for RG8, RG11, RG213, RG216 Coaxial Connectors

- For RG 8, RG 11, RG 213 and RG 216 ethernet N-series, .429"/.213"/.100"/.067" hex cavities
- Precision-machined hardened steel
- Fits ErgoCrimp® and ErgoCrimp Plus® tools

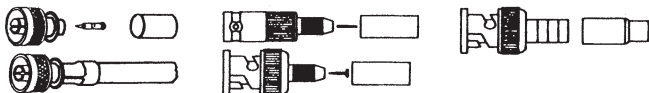

Cat No.	UPC No.	Packed	Description	Shelf Pack
D106	037103059444	Boxed	Die set	1

ErgoCrimp® Die Set for RG6, Belden® 1694A, Twinax, CATV Coaxial Connectors

- For RG 6 CATV "F" connectors - .360"/.324"/.068" hex cavities
- Hex BNC HDTV and cable "F" connectors
- Precision-machined hardened steel
- Fits ErgoCrimp® and ErgoCrimp Plus® tools

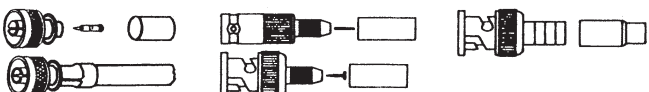

Cat No.	UPC No.	Packed	Description	Shelf Pack
D107	037103059413	Boxed	Die set	1

Xcelite

ErgoCrimp® Die Set for SMA, SMB, SFR, ST, SC Fiber Optic Connectors



- For fiber optic connectors requiring .128"/.151"/.213"/.197"/.178" hex crimps
- Precision-machined hardened steel
- Fits ErgoCrimp® and ErgoCrimp Plus® tools

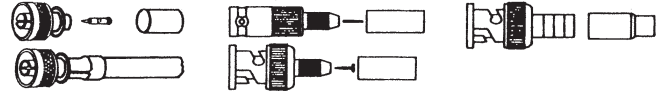

Cat No.	UPC No.	Packed	Description	Shelf Pack
D109	037103059437	Boxed	Die set	1

Modular Plug Die Set for RJ45 Connectors



- Modular plug die set for RJ45 connectors
- 8 position - 8 contact

Cat No.	UPC No.	Packed	Description	Shelf Pack
D110	037103197122	Boxed	Die set	1

Mini-Crimper/Maxi-Crimper Mechanical Crimping Tools

Xcelite® mechanical crimping tools have been designed to achieve maximum comfort, reliability, and durability. Their main features are:

One-handed Crimping

- The handle force needed for the crimping operation in most tools exceeds 60-70lbs. (27-32Kg)
- The average man and virtually all women cannot make a comfortable one-handed crimp
- Xcelite® crimping tools are designed with such a low handle force requirement that the crimp operation can be performed with only one hand

Handle Spread

- Other crimping tools on the market have open handle spreads equal to or greater than 6" at the point where the user places his grip
- This is too great a spread for the average male and female hand
- The Xcelite® mini-crimper has a handle spread of about 3 1/2"/88mm
- It is the smallest spread available in a tool this powerful
- The maxi-crimper, with about 20% more power, still has a handle spread under 4 1/2"/144mm
- Both tools fit comfortably in the average male or female hand
- With just one hand needed to hold the crimping tool, the user is now free to easily locate cable and connector in the jaw of the tool

Crimping Pressure

- The configurations of the crimping nests and indentors are designed to increase the tensile strength of the crimp
- The jaw pressure applies is scientifically calculated for optimum connections

Mini-crimper (MIC)

Length: 7.68"

Weight: 0.55lbs.

Open Handle Spread: 3.66"

Closed Handle Spread: 1.90"

Max. Crimp Force: 1,600lbs.

Maxi-crimper (MAC)

Length: 8.86"

Weight: 1.10lbs.

Open Handle Spread: 4.50"

Closed Handle Spread: 2.10"

Max. Crimp Force: 2,200lbs.

Reliability

- All components are made of high-quality Swedish steel and have been life tested for 50,000 cycles
- Precision manufacturing guarantees a uniform product of high accuracy
- After long wear, it is always possible to check the crimp dimensions with go/no-go gauges, and to adjust for eventual discrepancies by turning the patented excenter adjustment plate

Size

- Size has been **minimized** to allow single-handed operation and to ensure the tool fits easily into repair kits

Safety

- A ratchet device has been built in to guarantee that the user makes the exact same complete crimp every time
- Should the user start a faulty crimp, a safety release mechanism is built into the ratchet, allowing the user, with one finger, to open the tool before the cycle is complete

Economy

- Because of their considerable advantages in quality, speed, and efficiency, the payoff time for an investment in Xcelite® tools is extremely short.

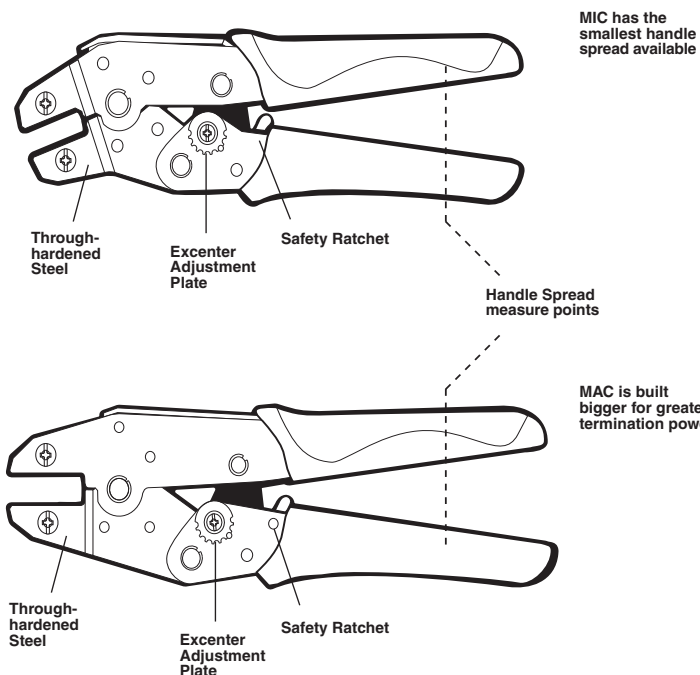

Maxi-Crimper for Insulated Terminals and Splices



- Maxi-Crimper built bigger for greater terminating power
- Crimps 22-10 AWG (.75-6.0mm²) red, blue and yellow insulated terminals and splices (die nests color-coded to AWG specs)
- Incorporates ratchet to ensure a full-cycle complete crimp every time
- Crimps exceed UL® standards for most terminals from AMP, 3M, T & B and many others



Cat No.	UPC No.	Packed	Description	Pack Wt.		Shelf Pack
				lb	kg	
MAC2210	037103489180	Boxed	Maxi-crimper tool	1.1	0.5	1
D2210	037103490186	Boxed	Die set for MAC2210	-	-	1

Mini-Crimper for Open Barrel D-subminiature Contacts



- Mini-Crimper smallest professional crimp tool of its kind
- Universal tool designed to crimp a wide range of open-barrel and D-subminiature contacts 30-20 AWG
- Versatile tool for pins, sockets, disconnects and other open-barrel contacts from AMP, MOLEX, ITT Cannon and others
- Incorporates ratchet to ensure a full-cycle complete crimp every time

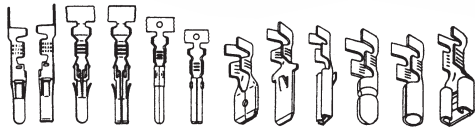

Cat No.	UPC No.	Packed	Description	Pack Wt.		Shelf Pack
				lb	kg	
MIC3020BL	037103490391	Boxed	Mini-crimper tool	0.55	0.25	1

32 AWG to 10 AWG Combination, Self-adjusting Wire Stripper



- Tool capable of stripping wires from 32 AWG to 10 AWG without adjustment
- Widest stripping capacity of any tool of its type
- Easily interchangeable stripping cassettes enables precision stripping
- Strips a wide range of insulation types, PVC to PTFE with just one tool. Tested to over 150,000 cycles
- The ergonomic design is lightweight, strong, and comfortable
- The tool issuitable for production of field service work
- Fine insulation can be stripped without damage to the conductor
- Low friction moving handle optimized grip span, and angled head

Cat No.	UPC No.	Packed	Description	Shelf Pack
SAS3210	037103197306	Boxed	Self-adjusting wire stripper	1

Interchangeable Replacement Blade for SAS3210 Combination Wire Stripper

- Interchangeable replacement blade for SAS3210 combination wire stripper
- Capable of stripping wires from 34 to 8 AWG without adjustment



Cat No.	UPC No.	Packed	Description	Shelf Pack
SAS3210RB	037103197276	Boxed	Interchangeable replacement blade	1

Interchangeable Replacement Blade for SAS3210 Combination Wire Stripper

- Interchangeable replacement blade for SAS3210 combination wire stripper
- Capable of stripping Teflon® insulation from 32 AWG to 10 AWG



Cat No.	UPC No.	Packed	Description	Shelf Pack
SAS3210TRB	037103197283	Boxed	Interchangeable replacement blade	1

Economical Coaxial Wire Stripper - Pre-adjusted for RG59 & RG6



- Tool specially designed to quickly and easily strip RG 59 and RG 6 cables for CATV “F” connectors
- Built-in stop (no adjustments needed)
- Replaceable blade cassette lasts 1,000-2,000 strips
- Convenient built-in belt clip
- Full operating instructions listed on back of blister card

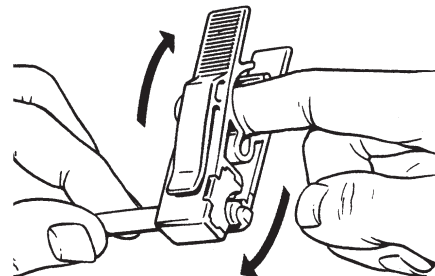
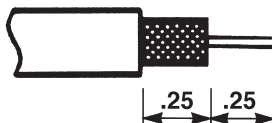

Cat No.	UPC No.	Packed	Description	Pack Wt.		Shelf Pack
				lb	kg	
2CSKCATV	037103045324	Carded	For RG59 and RG6	1/4	6	3
CATVC	037103045331	Boxed	Cassette, spare blades for 2CSKCATV	1/4	6	3

Cable Jacket Stripper, 0.43" Maximum Diameter

Xcelite



CJS100



- **Precise:** Fine adjustability and repeatability assured by 9 position blade cutting depth adjustment
- **Easy to use:** Simply squeeze together, insert cable, release and rotate once, remove from cable and pull off scrap insulation
- **Safe:** Smooth, rounded, pocketable, lightweight design. No exposed blades. Replacement blades are encased in a plastic cassette
- **Flexible:** Strips the jacket from most cables up to 0.43" (11 mm) in diameter
- **Durable:** Tested to over 50,000 cycles
- **Economical:** Replaceable blade (p/n CJS100B)

Cat No.	UPC No.	Packed	Description	Shelf Pack
CJS100	037103197061	Carded	Cable jacket stripper	1
CJS100B	037103197122	Boxed	Replacement blade	1

Round Cable Stripper, .178" - 1.57" Diameter

- By rotating the body of the tool, the blade can be fixed in any one of three positions to provide:

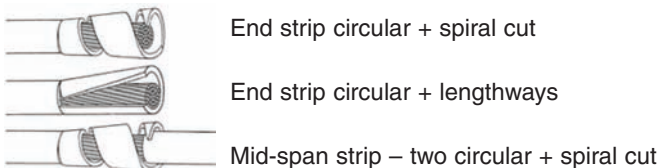
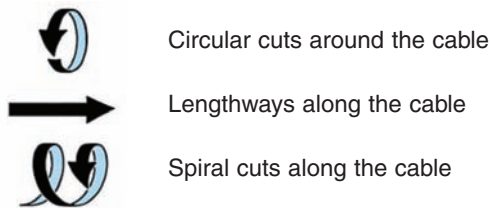

- Unique to this type of tool, the CJS200 features two interchangeable cable retention guides giving it an incomparable stripping capacity of 0.18" to 1.57" (4.5-40 mm) in one tool. Both cable guides are included with each tool. The CJS200 can replace two or more similar products in the toolbox
- Easy to use:** Positive locking positions for circular, lengthways, and spiral cuts
- No special tools required to interchange cable guides
- Safety strap can be attached to the eyelet at the base of the tool to prevent accidental dropping
- Ergonomic:** The well-balanced design features rests for thumb, first, and little fingers to ease in raising of the cable retention guides
- Durable:** Tested to over 100,000 cycles
- Economical:** Replacement blade available (p/n CJS200B). Can be stored in the tool body

Cat No.	UPC No.	Packed	Description	Shelf Pack
CJS200	037103197085	Carded	Round cable stripper	1

Accessories for CJS200 Round Cable Stripper

- CJS200B:** Replacement blade for CSJ200 round cable stripper
- CJS200LG:** Large cable guide for CJS200 round cable stripper
- CJS200SG:** Small cable guide for CJS200 round cable stripper



CJS200B



CJS200SG



CJS200LG

Cat No.	UPC No.	Packed	Description	Shelf Pack
CJS200B	037103197092	Boxed	Replacement blade for CSJ200 round cable stripper	1
CJS200LG	037103197108	Boxed	Large cable guide for CSJ200 round cable stripper	1
CJS200SG	037103197115	Boxed	Small cable guide for CSJ200 round cable stripper	1

Coaxial Wire Stripper - Full Kits and Pre-adjusted Models

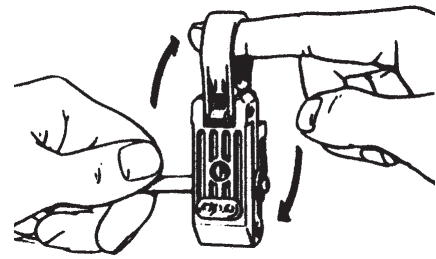
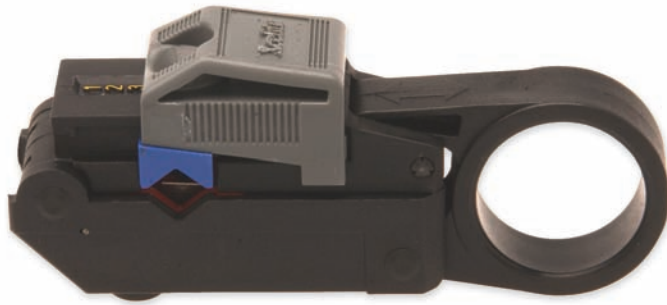

- Fastest accurate coax-stripping system
- Coaxial cable from .10" to .30" (1.87-7.6mm) in thickness (RG 178 up to RG 6) stripped in seconds
- Also removes dielectric, braid and outside insulation
- Xcelite® system available with different color-coded cassettes designed to meet exact stripping specifications
- Cassettes changed in seconds
- Available in full kits for users of many different cable sizes
- Special, pre-adjusted models or cassettes with special strip lengths made upon request

Full Kits - Coaxial Wire Stripper

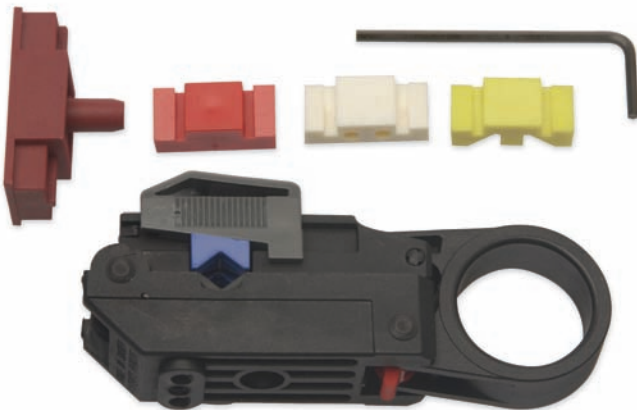

3CSKWH

- Full kit designed for user who strips many different size cables (from .1" to .3"/2.5-7.6mm)
- Contains cassette indicated, all 4 Xcelite® V-Blocks, hex wrench and instruction sheets covering most possible applications
- 3-step models not recommended for cable with hollow dielectric (RG 62) or foam dielectric (use 2-step models instead)
- Cable O.D. range: .10"-.30" (2.5-7.6mm), RG 174 to Belden® 8281 or RG 6

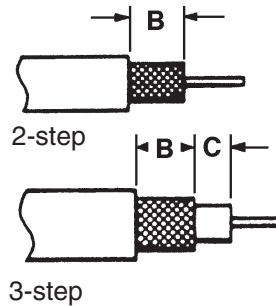

Kit Cat No.	UPC No.	Type	Packed	Cassette Cat No. & Color	Cassette UPC No.	Blade Spacing				Cover Strip Length Specs.				Shelf Pack
						(B) in	(B) mm	(C) in	(C) mm	(B) in	(B) mm	(C) in	(C) mm	
2CSKR	037103489456	2-step	Pouched	2CR red	037103489493	0.24	6.0	-	-	7/32-1/4	5.6-6.3	-	-	1
2CSKB	037103489470	2-step	Pouched	2CB blue	037103489616	0.27	6.8	-	-	1/4-9/32	6.3-7.1	-	-	1
2CSKY	037103489463	2-step	Pouched	2CY yellow	037103489609	0.47	12.0	-	-	7/16-1/2	11.1-12.7	-	-	1
3CSKBR	037103489432	3-step	Pouched	3CBR brown	037103489579	.328	8.3	.109	2.7	5/16-11/32	7.9-8.7	1/16-7/64	1.6-2.8	1
3CSKGN	037103489449	3-step	Pouched	3CGN green	037103489586	.235	6.0	.235	6.0	7/32-1/4	5.6-6.3	13/64-1/4	5.1-6.3	1
3CSKWH	037103489975	3-step	Pouched	3CWH white	037103489986	.266	6.7	.063	1.6	1/4-17/64	6.3-6.7	1/16-3/32	1.6-2.4	1

Note: 3-STEP models are not recommended for cable with hollow dielectrics (RG 62) or foam dielectrics. Use 2-STEP models instead. Cable O.D. range: .10"-.30" (2.5-7.6mm) e.g. RG174 to Belden® 8281 or RG6.

Cassettes

- The cassette determines the strip dimension that your stripper will give
- New tool body design allows all cassettes to be used in any 2 step or 3 step full kit or pre-adjusted model
- Cassettes can be interchanged in seconds in the tool body

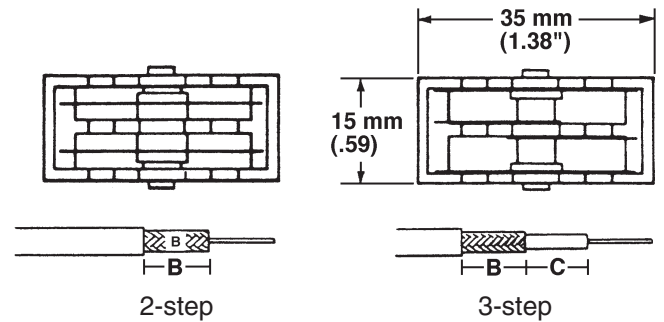

Cassette Cat No. & Color	Cassette UPC No.	Type	Packed	Blade Spacing				Cover Strip Length Specs.				Shelf Pack
				(B)		(C)		(B)		(C)		
				in	mm	in	mm	in	mm	in	mm	
2CR red	037103489493	2-step	Carded	0.24	6.0	-	-	7/32-1/4	5.6-6.3	-	-	1
2CB blue	037103489616	2-step	Carded	0.27	6.8	-	-	1/4-9/32	6.3-7.1	-	-	1
3CBR brown	037103489579	3-step	Carded	0.328	8.3	0.109	2.7	5/16-11/32	7.9-8.7	-	-	1
3CGN green	037103489586	3-step	Carded	0.235	6.0	0.235	6.0	7/32-1/4	5.6-6.3	-	-	1

Belden® is a registered trademark of Belden, Inc.

Cat. No.	Page	Cat. No.	Page	Cat. No.	Page	Cat. No.	Page
10	17	44CGV	66	9922	1, 28, 36	99832	27
100X	63, 70	46CG	31, 66, 70	9922BP	28, 34	998M	26, 33
100XV	63	46CGV	66	9923	1, 28, 36	998MM	26, 37
101S	63	48CG	66	9923BP	28, 34	998XTD	29
101SV	63	48CGV	66	9924	1, 28, 36	999	26, 37
103S	64	4MM	19	9924BP	28, 34	99964	1, 28, 33, 36
103SV	64	50CG	63	9925	1, 28, 36	99964BP	28, 34
104CG	64	50CGV	63	99250	27, 31, 32, 33, 37	999MM	26, 37
104CGV	64	51NCG	62, 70	99250V	27	99K	32
105CG	64	51NCGV	62	9925BP	28, 34	99MP	33
105CGV	64	52NCGV	31, 62	9925XTD	29, 35	99MPK	33
105SCGV	64	54CG	60	9926	1, 28, 33, 36	99PA	30, 33
10M	19	54CGV	60	9926BP	28, 34	99PA50	33
10MM	19	55MM	19	9927XTD	29, 35	99PAV	30
10V	17	55NCG	31, 61	993	25, 31	99PR	32
11	17	55NCGV	61	9930XTD	29, 35	99PS40	36
1178D	58	57CG	62	99312	27, 33	99PS40BP	34
1178M	58	57CGV	62	9938	29, 31, 33	99PS40BPV	34
12	17	59NCG	62	994	25, 33	99PS40V	36
127TB	20	5MM	19	9945MM	37	99PS41MM	36
134CG	60	6	17	994MM	26, 37	99PS41MMBP	35
13MM	20	600	16	994R	25	99PS50	37
14	17	600V	16	994V	25	99PS50V	37
147TB	20	64CG	61	9955MM	26, 37	99PS51MM	37
157	20	64CGV	61	995MM	26, 37	99PS60	38
170D	58	66NCG	61	996	26, 31, 32, 33, 37	99S10	26, 31, 33
170M	58	66NCGV	61	9961	2, 29, 33, 38	99S12	26, 31, 33
175D	58	76C	70	9962	2, 29, 38	99S8	26, 31, 33
175M	58	7MM	19	9963	2, 29, 38	99SM	31
177	20	8	17, 70	9964	2, 29, 38	99SMK	31
18120	6	80V	66	9965	2	99SMX	31
2178D	58	86CG	65	9966	2, 29, 38	99SPC	32
2178M	58	86CGV	65	9967	2, 29, 38	99X10	30, 31
25	14	8M	19	9969	2, 29, 33, 38	99X10V	30
2CB	93	8MM	19	996MM	26, 37	99X5	30, 33, 34, 35, 36, 37, 38
2CR	93	991 25, 31, 32, 33, 34, 35, 36, 37, 38		996XTD	29	99XTD7	35
2CSKB	92	9910	26, 37	997	26, 37	C1K	56
2CSKCATV	90	9910M	26	9971MM	28, 36	CATVC	90
2CSKR	92	9910MM	26, 37	9972MM	28, 36	CJS100	90
2CSKY	92	9910XTD	29, 32, 35	9973MM	28, 36	CJS100B	90
32H	63	9911	26, 37	9974MM	28, 36	CJS200B	91
33220	6	9911MM	26, 37	9975MM	28, 36	CJS200LG	91
33HV	63	9912	26, 37	99764	1, 28, 33, 36	CJS200SG	91
378D	59	99125	27, 33	99764BP	28, 34	CK20	15
378M	59	9914	26	9976MM	28, 36	CK23	15
378SMD	59	9915XTD	29, 32, 35	9977MM	28, 36	CK3	16
378SMM	59	9916	26, 31, 32, 33	997MM	26, 37	CN255	49
3CBR	93	991R	25	998	26, 32, 37	CN255G	49
3CGN	93	991V	25	99811	27, 31, 32, 33, 37	CN255V	49
3CSKBR	92	992	25	99811V	27	CN54G	52
3CSKGN	92	9920	1, 28, 33, 36	99820	27, 32, 33	CN55G	52
3CSKWH	92	9920BP	28, 34	99821	27, 31, 32, 33, 37	CN7776	55
413MM	21	9920XTD	29, 35	99821V	27	CR1	15
42HV	63	9921	1, 28, 36	99822	27, 31, 32, 33, 37	CR1V	15
43HV	63	9921BP	28, 34	99822V	27	CR2	15
44CG	66			99831	27	CR2V	15

Cat. No.	Page	Cat. No.	Page	Cat. No.	Page	Cat. No.	Page
D100	82, 83	L4V	53	MS545JV	44	R181V	6
D101	84	L8	18	MS545V	44	R182	7
D102	84	L8M	19	MS549J	40, 42	R182V	7
D104	84	L8MV	19	MS549JV	42	R183	6, 7
D105	85	LC665J	40, 48	MS54J	42	R183V	6, 7
D106	85	LN11	13	MS54V	42	R184	7, 70
D107	85	LN15MM	12	NN54	54, 56	R184V	7
D109	86	LN20	1, 12	NN542	53	R186	7
D110	86	LN20BP	13	NN54G	54	R186V	7
D2210	88	LN21	1, 12	NN54GV	54	R188	7
DN54G	53, 56	LN21BP	13	NN54V	54	R188V	7
DN54GV	53	LN21V	12	NN55	54	R31610	7
EC54J	40, 48, 56	LN22	1, 12	NN55G	54	R3163	7
ECP000	83	LN225	49	NN55V	54	R3164	7
ECP100	82	LN22BP	13	NN7776	55	R3164V	7
ECP101	83	LN22V	12	NN7776G	55	R3166	7
EGA54J	40, 48	LN23	1, 12	NN7776V	55	R3166V	7
ELN54	50	LN23BP	13	P1	21, 23	R3168	7
ELN54G	50	LN23V	12	P10	22, 23	R3322	6
EMS54	40, 43	LN24	1	P12S	9, 70	R3322V	6
EMS543J	40, 44	LN25	1, 12	P12S20	6	R3323	6
EMS545J	45	LN25BP	13	P12SV	9	R3323V	6
EMS549J	40, 43	LN25MM	12	P18	1	R3324	6
ENN54	54	LN26	1	P19	1, 23	R3324V	6
FSD1	16	LN27	1	P20	1, 23	R388	7
FSD1V	16	LN28	1	P21	1	R5164	7
GA54J	40, 47	LN28BP	13	P22	1, 23	R5166	7
GA54JV	47	LN2MM	12	P23	1, 23	R5168	7
HS10	18	LN3MM	12	P24	1	R5323	7
HS10V	18	LN4MM	12	P3321	21	R5324	7
HS11	18	LN54	49, 56	P35MM	22	R5325	7
HS11V	18	LN542	50	P3MM	22	RB1	15
HS12	18	LN54G	50	P4	22	RB2	15
HS12V	18	LN54GV	50	P5	22	RN54	52
HS14	18	LN54V	49	P6	22, 23	S141	8, 70
HS14V	18	LN55	51	P764	1	S1415JS	40, 46
HS16	18	LN55V	51	P8	22, 23	S144	8
HS16V	18	LN764	1, 12	P964	1	S146	8
HS18	18	LN764BP	13	PS120	22	S2K	59
HS18V	18	LN774512	54	PS120V	22	S3161	8
HS6	18	LN775512	55	PS121MM	22	S3163	8
HS618	21	LN775512G	55	PS130	23	S3164	8
HS7	18	LN775512V	55	PS130V	23	S3166	8
HS8	18	LN8MM	13	PS88	21	S3812	8
HS8V	18	LN964	1, 12	PS88V	21	S388	8
HS9	18	LN964BP	13	PS89	23	S424JS	40, 45
HS9V	18	LN9BP	14	PS89V	23	S424JSV	45
K22	66	M60	24	PS90MM	24	S475JS	45
K22V	66	M60V	24	R1410	7	S475JSV	45
L10	18	MAC2210	88	R144	7, 70	S5164	8
L10M	19	MIC3020BL	88	R144V	7	S5166	8
L10MV	19	MS54	40, 42, 56	R146	7	S5168	8
L11	18	MS543J	40, 43	R146V	7	S54KS	40, 46
L12	18	MS543JV	43	R148	7	S54N	40, 46
L4	53	MS545	40, 44	R181	6	S54S	40, 46
L4G	53	MS545J	40, 44	R1810	7	S54SV	46

Cat. No.	Page	Cat. No.	Page	Cat. No.	Page	Cat. No.	Page
S55KS	40, 47	XL75V	65				
S55N	40, 47	XN100	68				
S55S	40, 47	XN100B	68				
SAS3210	88	XN200	68				
SAS3210RB	89	XN210	68				
SAS3210TRB	89	XN300	68				
SD3V	11	XNB101	69				
SDR11	8	XNB103	69				
SDS44	9	XNB103B	69				
SDX22	11	XNB105	69				
SN54	40, 51, 56	XNB201	69				
SN55	40, 51	XNB203	69				
SN55V	51	XNB205	69				
SRX33	11	XNB301	69				
SX101	9	XNB305	69				
SX102	9	XNS100	69				
TA2	21, 22, 23, 24	XP1	4				
TC100MT	72	XP1B	4				
TC100ST	72	XP1CHG	4				
TC55	40, 51	XP600	4				
TCA100ST	73	XP700	5				
TCA150ST	76	XPE500	5				
TCMB100MT	74	XPE700	5				
TCMB100MTW	71	XPTX600	4				
TCMB100ST	74	XSST3	67				
TCMB100STW	71	XSST3CV	67				
TCMB150MT	77	XSST3V	67				
TCMB150ST	77	XSST4V	67				
TCMG150MT	78	XSST5V	67				
TCMG150ST	78	XSST7V	67				
TCMG200ST	81	XST100	10				
TCS100ST	75	XST100V	10				
TCS150MT	79	XST101	10				
TCS150ST	79	XST1010	10				
TCS200ST	80	XST101V	10				
TKX11	70	XST102	10				
TSD1V	17	XST1020	10				
W9210ME	70	XST102V	10				
X100	10	XST3	11				
X101	10, 70	XST5	11				
X1010	10	XTD10	3, 11				
X101V	10	XTD10XL	11				
X102	10	XTD15	3, 11				
X1020	10	XTD15XL	11				
X102V	10	XTD20	3, 11				
X103	10	XTD25	3, 11				
X108	10	XTD27	3, 11				
X108V	10	XTD30	3, 11				
XHT412	67	XTD6	11				
XHT434	67	XTD6V	11				
XHT600	67	XTD8	3, 11				
XHT612	67	XTD8V	11				
XHT678	67						
XHT700	67						
XL70	65						
XL75	65						

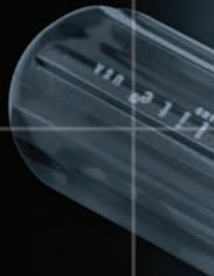

Cooper Hand Tools
World Headquarters
1000 Lufkin Road Apex, NC 27539

Telephone919-387-0099
Fax919-387-2614

Customer Service U.S.:

Telephone:
North866-907-9706
South866-907-9718
Midwest.....866-907-9715
West/SW866-907-9716
Hardware919-362-1670

Fax:
North800-854-5137
South800-854-5139
Midwest.....800-854-5138
West/SW800-546-7312
Hardware877-387-0415
Export919-387-2402

Customer Service Canada:

Cooper Hand Tools-Canada
164 Innisfil Street
Barrie, Ontario
Canada L4N 3E7

Phone:705-728-5564
Fax:800-403-8665



Campbell® CaulkMaster® Crescent® Diamond® Erem® Kahmetics® Lufkin®
Nicholson® Plumb® H.K.Porter® Weller® Wire-Wrap® Wiss® Xcelite®

Mouser Electronics

Authorized Distributor

Click to View Pricing, Inventory, Delivery & Lifecycle Information:

[Apex Tool Group:](#)

[80](#)